







The *LFI-3751 with Autotune PID* is a high performance temperature controller specifically designed for sensitive applications. Now with *Autotune PID* capability, the LFI-3751 automatically optimizes virtually any thermal load; reduce overshoot or improve temperature stability with the push of a button.

Key Features . . .

- < 0.002°C temperature stability even at ambient
- Controls temperature with thermistors, RTDs, LM335, or AD590

. . . The Wavelength Advantage

-  *Autotune PID*
-  PID Constants adjustable via front panel
-  Auto-ranging thermistor & RTD bias current
-  Bipolar or Unipolar output current operation
-  High and Low Temperature Limits
-  Auxiliary temperature sensor input
-  Analog input allows for external temperature control (Analog model only)
-  Addressable RS-232 interface

LFI-3751 with Autotune PID Thermoelectric Temperature Controller



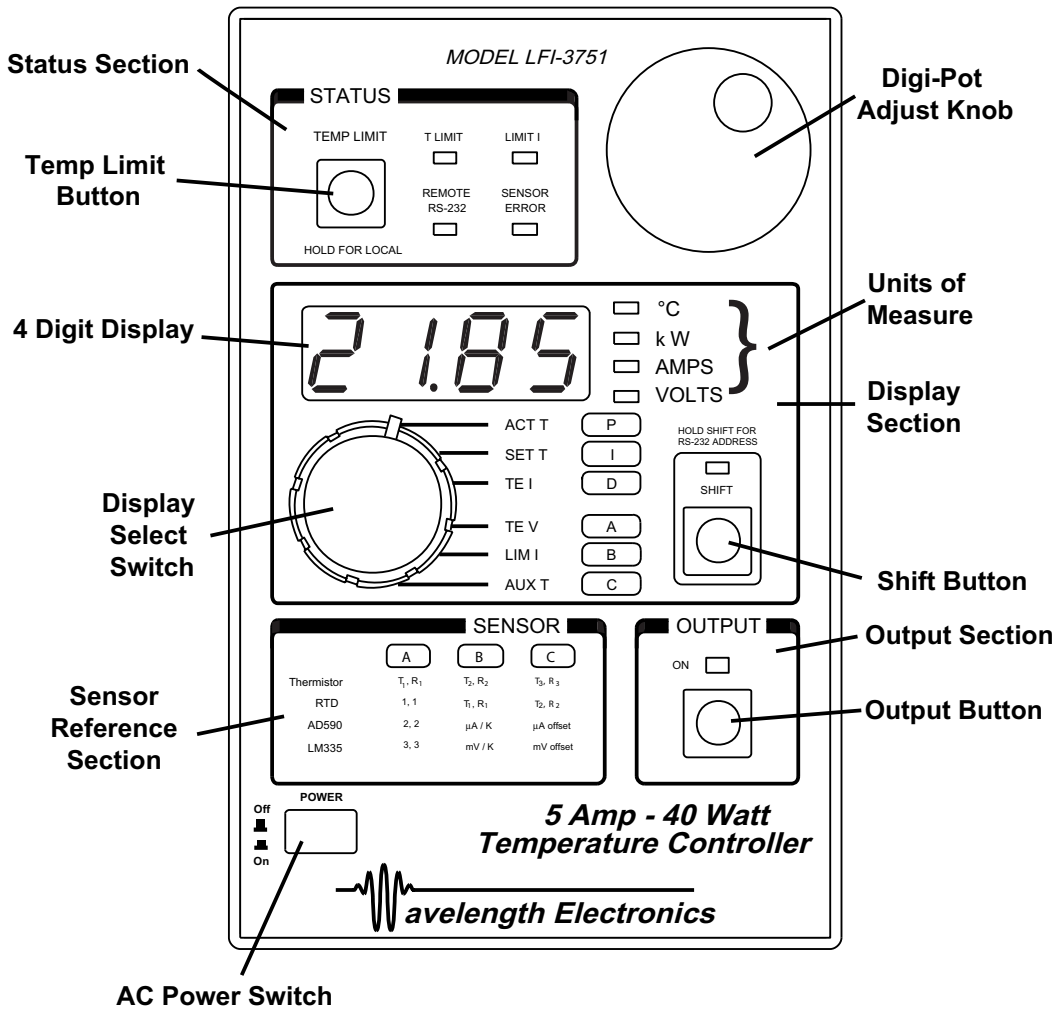

LFI3751-00400-C Rev D

The Front Panel at a Glance



Front Panel Operations at a Glance

Operation Legend

-  While displayed, Parameter can be changed by rotating Digi-Pot Adjust Knob
-  Digi-Pot Adjust Knob is disabled. Monitor parameter only.
-  LED is OFF
-  LED is lit SOLID
-  LED FLASHES

Adjusting Limit Current

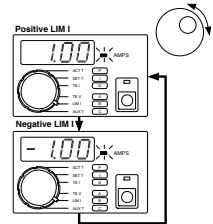

Rotate the Display Select Switch to LIM 1. Positive Limit Current (0 to +5 Amps) will alternate with the Negative Limit Current (-5 to 0 Amps).

Limit Current LED

LIMIT I

 **LIMIT I LED flashes:**
TE Current is limited by LIM I settings.

WAIT - Most thermal loads require maximum current while initially controlling to temperature. To control properly, the output current must be less than the LIM I current setting.

CAUTION: Improperly set LIM I can damage your thermoelectric

Adjusting Temperature Limits : -199.9 to +199.9°C

TEMP LIMIT

Note: Temperature Limit does not operate in Resistance Mode for thermistors or RTDs.

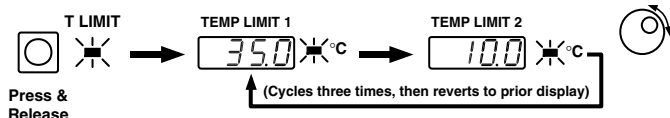

Press & Release

↑ (Cycles three times, then reverts to prior display)

Temperature Limit LED & Correcting the Temperature Limit Error

T LIMIT LED flashes: Sensor temperature is outside temperature limits. Output is disabled.

Press Output Button to clear error.

Press Output Button to re-enable output current.

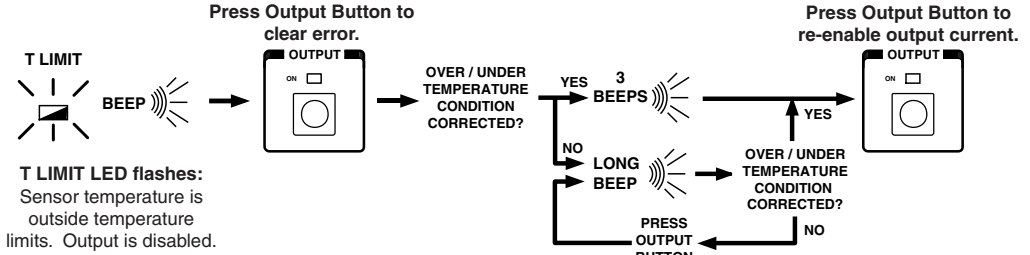

OVER / UNDER TEMPERATURE CONDITION CORRECTED?

YES 3 BEEPS

NO LONG BEEP

PRESS OUTPUT BUTTON

OVER / UNDER TEMPERATURE CONDITION CORRECTED?

YES

NO

Sensor Error LED & Correcting the Sensor Error

SENSOR ERROR LED flashes: Sensor is either OPEN or SHORTED. Output forced OFF.

Press Output Button to clear error.

Press Output Button to re-enable output current.

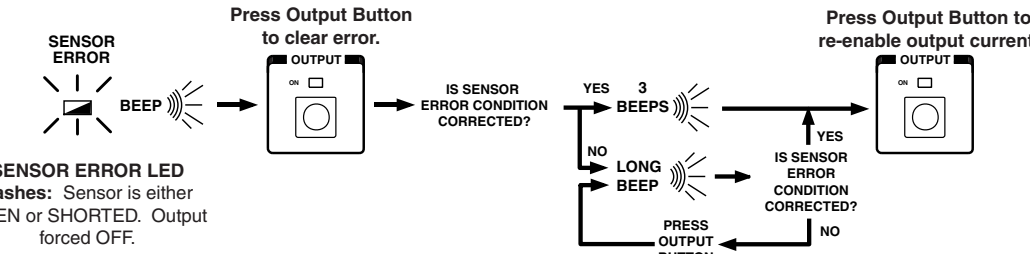

IS SENSOR ERROR CONDITION CORRECTED?

YES 3 BEEPS

NO LONG BEEP

PRESS OUTPUT BUTTON

IS SENSOR ERROR CONDITION CORRECTED?

YES

NO



Adjusting RS-232 Address

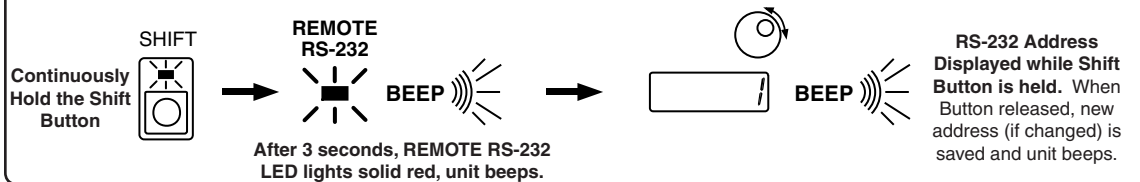

Remote RS-232 LED

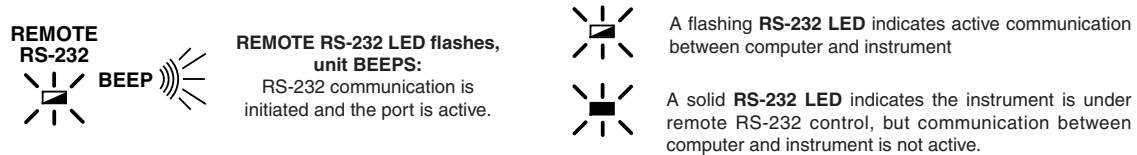

Enable / Disable Output Current During Continuous RS-232 Operation

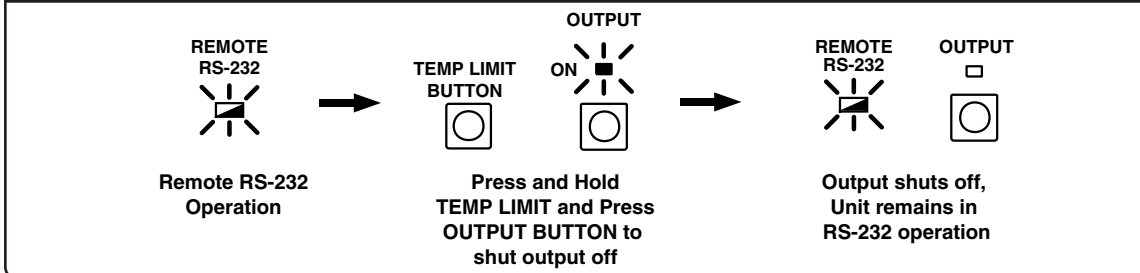

Revert to Local Mode Operation

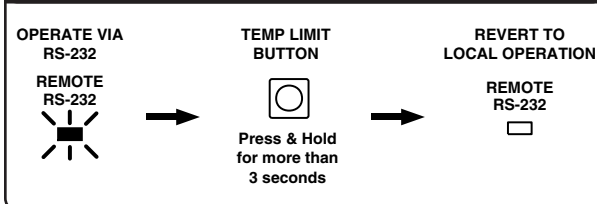

Enable / Disable Output Current

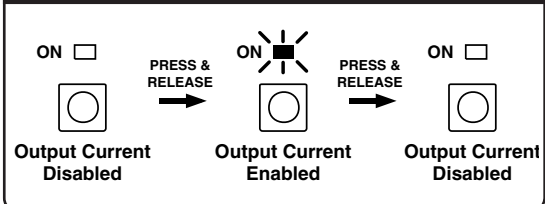

The Front Panel at a Glance
Quick Autotune PID Operation

Quick Autotune PID Operation

Step 1. Adjust the Limit Current below the rated maximum current for your thermoelectric or resistive heater.

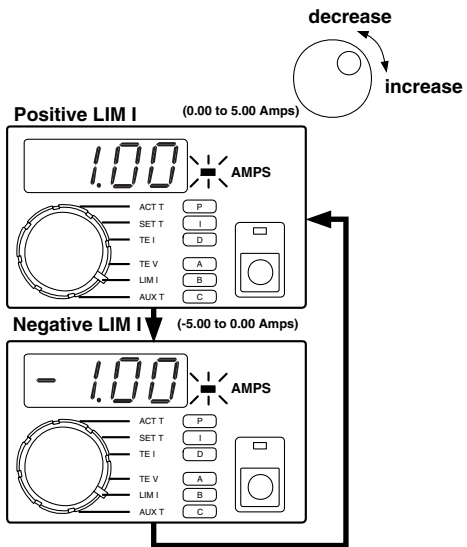

Step 2. Adjust the Temperature Setpoint to your desired operating temperature.

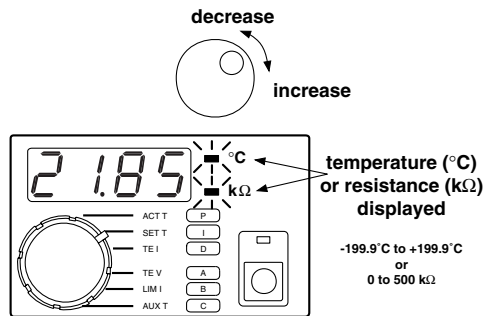

Continued next page...



The Front Panel at a Glance
Quick Autotune PID Operation

Quick Autotune PID Operation, continued

Step 3. Adjust the P term to display AutS or Autd.

AutS: Setpoint Response Optimization
 Autd: Disturbance Rejection Optimization

(Wait about two seconds before enabling the output current.)

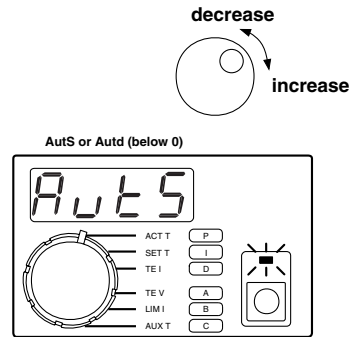

Step 4. Begin Autotune Optimization: Enable Output Current.

The time to complete an Autotune optimization sequence varies from load to load. While tuning, the ON LED will flash. When complete, the LFI-3751 beeps once and the ON LED lights solid.

Three audible beeps indicate if the Autotune sequence is aborted. The ON LED is not lit. If the actual sensor temperature exceeds the high or low temperature limits the optimization will abort.

See Page 23 for more detail on the LFI-3751 Autotune feature.

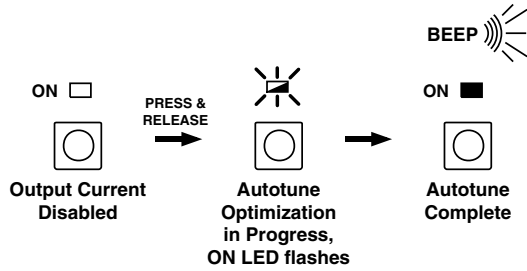

Autotune Process

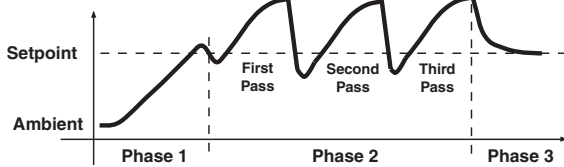

Phase 1: The LFI-3751 ramps the thermoelectric current to drive the load toward the setpoint temperature.

Phase 2: The LFI-3751 performs three characterization passes.

Phase 3: The LFI-3751 reverts to normal operation, saving the optimized P, I, and D settings in non-volatile memory and settling in at the setpoint temperature.

The Front Panel at a Glance
Displaying and Adjusting Values on the Front Panel

Display Section

SHIFT OFF		SHIFT ON	
<p>ACT T -199.9°C to +199.9°C OR 0 to 500 k Ω</p> <p>°C OR k Ω</p>	<p>P AutS or Autd (Autotune PID) or 1 to 100 Amps / Volt</p>		
<p>SET T -199.9°C to +199.9°C OR 0 to 500 k Ω</p> <p>°C OR k Ω</p>	<p>I OFF (0) OR 0.4 to 10.0 secs.</p>		
<p>TE I -5.00 to +5.00 Amps</p> <p>AMPS</p>	<p>D OFF (0) OR 1 to 100 secs.</p>		
<p>TE V -12.0 to +12.0 Volts</p> <p>VOLTS</p>	<p>A</p> <p>[A1] 10.00 °C ↓ [A2] 19.90 k Ω</p>		
<p>LIM I 0.00 to +5.00 Amps</p> <p>POSITIVE 10.0 AMPS ↓ NEGATIVE -10.0 AMPS</p>	<p>B</p> <p>Thermistors or RTDs (T, R) data AD590, LM335, Slope [B1] 25.00 °C [B1] only [B2] 10.00 k Ω</p>		
<p>AUX T -8.00°C to +150.00°C (typical)</p>	<p>C</p> <p>Thermistors or RTDs (T, R) data AD590, LM335, Offset [C1] 40.00 °C [C1] only [C2] 5.33 k Ω</p>		

Default Sensor Configuration

Sensor Type	A		B		C	
	[A1]	[A2]	[B1]	[B2]	[C1]	[C2]
Thermistor	10°C	19.9 kΩ	25°C	10 kΩ	40°C	5.326 kΩ
RTD	1	1	0°C	0.100 kΩ	100°C	0.139 kΩ
AD590	2	2	1 μA / K	-	0 μA	-
LM335	3	3	10 mV / K	-	0 mV	-

Rear Panel at a Glance

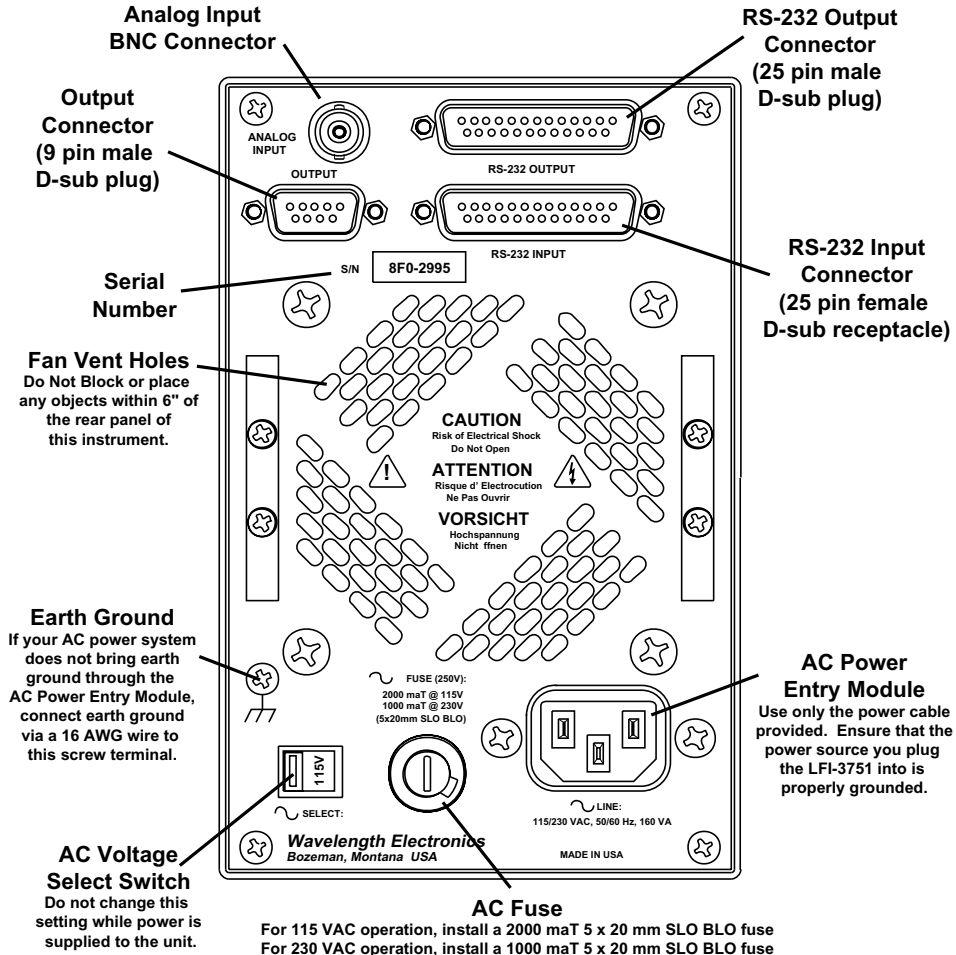

Output
9 pin male D-sub plug

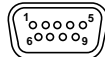

1	TEC +
2	TEC -
3	Aux Sensor +
4	*Sensor -
5	Main Sensor +
6	AD590 Voltage
7	*Fan -
8	*Fan+ (+12 V)
9	*-12 V

* Thermally Fused to 100 mA

RS-232 Input
25 pin female D-sub receptacle

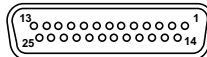

2	Instrument Receive (In)
3	Instrument Transmit (Out)
7	Signal Ground
5, 6, 8, & 20	shorted
All other pins are floating	

RS-232 Output
25 pin male D-sub plug

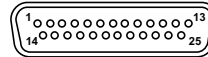

2	Peripheral Transmit (Out)
3	Peripheral Receive (In)
7	Signal Ground
All other pins are floating	

In This Book

Quick Start. Chapter 1 prepares the temperature controller for use and familiarizes you with a few of its features.

Front Panel Operation. Chapter 2 details the features and functions of the front panel. You will find this chapter useful whether you are operating from the front panel or from the RS-232 interface.

Rear Panel Operation. Chapter 3 details the rear panel features and connector pin outs.

Remote Interface Reference. Chapter 4 details the RS-232 commands and responses. Remote interface programs are provided to help you develop programs for your temperature control application.

Specifications. Chapter 5 lists the temperature controller specifications.

If your LFI-3751 fails within one year of purchase, Wavelength Electronics will repair it free of charge. If you have questions relating to the operation of the LFI-3751, you can contact Technical Support:

Call (406) 587-4910 in the U.S.
Fax (406) 587-4911
email sales@teamwavelength.com

If you have purchased the controller from an international distributor, please contact them for technical support or repairs.



This page intentionally left blank.



Table of Contents

Chapter 1: Quick Start	13
Preparing the Temperature Controller for Use	15
Nine Steps to Operating the LFI-3751	17
Chapter 2: Front Panel Operation	21
Autotune PID Operation.....	23
Theory of Autotune PID	30
Controlling Temperature with Thermistors	35
Controlling Temperature with RTDs	39
Controlling Temperature with an AD590	45
Controlling Temperature with an LM335	48
Controlling Temperature with an LM35	51
Sensor Error Condition.....	55
Setting Limit Currents.....	56
Setting Temperature Limits	57
Manually Setting the P, I, and D Constants	58
Setting Operating Temperature or Resistance	60
Enabling Output Current	61
Measuring Thermoelectric Current and Voltage	62
Measuring Auxiliary Thermistor Temperature.....	63
Setting the RS-232 Address	66
Operating with Resistive Heaters	67
Chapter 3: Rear Panel Operation	69
Connector Pinouts	71
BNC Connector.....	73
AC Power.....	74



Chapter 4: Remote Interface Reference	75
RS-232 Interface Configuration.....	77
RS-232 Command and Response Packet Formats	80
Standard Command Code Listing	82
Calibration Command Code Listing	85
Diagnostic Command Code Listing.....	86
End Code Listing.....	87
Starting RS-232 Communication with the LFI-3751	89
Configuring the Sensor	90
Measuring Actual Temperature or Resistance.....	94
Setting the Limit Currents	95
Setting Temperature Limits	96
Autotune PID & Setting the P, I, and D Constants	97
Setting Temperature Setpoint.....	99
Setting Resistance Setpoint.....	100
Enabling and Disabling the Output Current	101
Measuring Thermoelectric Current and Voltage	102
Measuring Auxiliary Sensor Temperature.....	103
Setting Gain for Analog Input Signal (Rear Panel BNC Connector).....	104
Checking the Alarm Status.....	105
Halting the Processor	106
Reverting to LOCAL Mode.....	107
Entering the PASSWORD.....	108
Reading Serial & Model Numbers, Firmware Version	109
Calibration - Sensor Bias Current and AD590 Sense Resistance	110
Calibration - ACT T, TE I, TE V uncalibrated voltages	112
Calibration - Measurement Slopes & Offsets	113
Calibration - SET T Slopes & Offsets.....	115
Calibration - TE Limit Current Slopes & Offsets.....	116
RESTORE Calibration Defaults	117
Diagnostic - Lamp Control	118
Diagnostic - Switch Status	119
Diagnostic - Digi-Pot Status	120
End Code Reference	121
Calculating FCS.....	123
Example BASIC Control Program for IBM PC Compatible Machines.....	124
Chapter 5: Specifications	127
General Specifications.....	129
Electrical Specifications	129
Mechanical Specifications.....	130
Appendix:	
CAT-220 Cable Accessory Diagram	133



Chapter 1: Quick Start



Quick Start

This chapter shows how to set up an LFI-3751. Become familiar with the temperature controller by following the *Nine Steps to Operating the LFI-3751* for a thermoelectric load with a 10 k Ω thermistor temperature sensor. Later chapters expand on this information and offer complete reference information.



Preparing the Temperature Controller for Use

The following steps help you verify the temperature controller is ready for use.

A Verify you have received these items.

If anything is missing, contact Wavelength Electronics or your nearest international distributor.

- One power cord
- 9 pin D-Sub receptacle (solder cup) and metal hood
- AC fuses (Two each for 115V or 230V operation)
- 50 Ω BNC terminator (Analog version only)
- Certificate of Calibration
- This User's Guide
- Benchlink software (3.5" floppy included with this User's Guide)

B Verify the power line voltage setting.

The line voltage is set to the proper value for your country when the temperature controller is shipped from the factory. The available settings are 115 or 230 VAC. If the voltage setting is incorrect, change it and check that the correct fuse is installed. If fuses are not available locally, call the Wavelength Electronics Technical Support Group or your international distributor to order new fuses.

Remove power cord. Change switch to proper voltage.



Remove fuse holder assembly and verify fuse rating or install proper fuse.

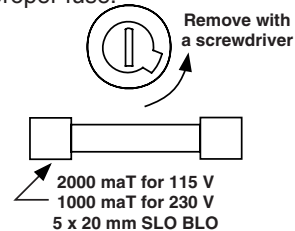

C Connect power cord and power on the LFI-3751.

Ensure the power source you plug the temperature controller into is properly grounded. Once the **AC Power Switch** on the front panel is pressed in, all LEDs on the front panel will light up while the temperature controller performs its power-on self test. After the test, the temperature controller is ready for normal operation.



D Perform a complete self test.

The complete self test is a more extensive set of tests than those performed at power-on. Hold down the **Shift Button** as you power the unit on with the **AC Power Switch**. A complete self test will start after holding the **Shift Button** for three seconds. If the self test is successful, "PASS" is displayed. If the self test is not successful, "FAIL" is displayed. If "FAIL" is displayed, see Step F for information on returning the unit to Wavelength for repair.

E If the temperature controller does not turn on.

Verify that there is AC power to the temperature controller. First, check that the **AC Power Switch** is in the ON position. Also, make sure the power cord is firmly plugged into the **Power Entry Module** on the rear panel. Check that the fuse in the rear panel fuse holder is in place and functional. You should also make sure that the power source you plugged the temperature controller into is energized.

F If the controller fails step D or still does not turn on.

Call your nearest Wavelength Electronics sales office for instructions on returning the temperature controller to Wavelength for service. In North America, call the factory directly at (406) 587-4910, Fax to (406) 587-4911, or email Customer Service at sales@teamwavelength.com. If you live outside North America, contact the international distributor you purchased the unit from.

Nine Steps to Operating the LFI-3751

These nine basic steps will familiarize you with the LFI-3751 temperature controller. This example controls a thermoelectric load to 25°C using a 10 kΩ thermistor. Complete details are included in later chapters.

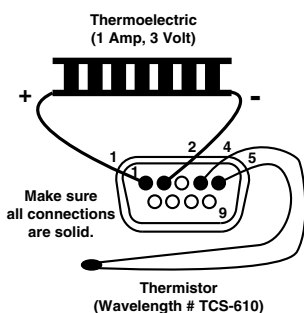

1 Wire Output Connector

Output Connector
 9 pin D-sub plug (male)
 PINOUT

1	TEC +
2	TEC -
3	Aux Sensor +
4	*Sensor -
5	Main Sensor +
6	AD590 Voltage
7	*Fan -
8	*Fan + (+12 V)
9	*-12 V

This 9 pin D-Sub male plug requires a mating female receptacle. Wire the thermoelectric module to pins 1 (positive lead) and 2 (negative lead). Wire the sensor (a thermistor in this example) to pins 4 & 5. The remaining hookups are optional. If you need a fan to cool a heatsink, wire a +12 V fan (100 mA maximum) to pins 8 & 7. If you need a second sensor to monitor an auxiliary zone (ambient, heatsink...) wire a 10 kΩ thermistor to pins 3 & 4. Install the 50 Ω BNC terminator on the **Analog Input BNC** on the rear panel.

* Thermally Fused to 100 mA

Steinhart-Hart Thermistor Equation

$$\frac{1}{T} = \chi_1 + \chi_2 \ln(R) + \chi_3 (\ln(R))^3$$

T = Temperature (Kelvin)
 R = Resistance (Ohms)

Graph of Resistance vs. Temperature for TCS-610 10 kΩ Thermistor

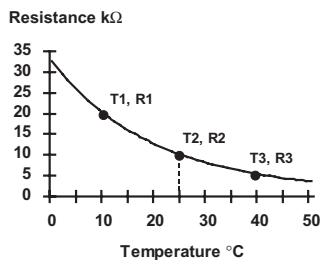

2 Configure Sensor

The change in resistance vs. temperature of a thermistor can be modeled by the Steinhart-Hart Thermistor equation. The LFI-3751 calculates the three coefficients (χ_1 , χ_2 , & χ_3) from three (Temperature, Resistance) data pairs that you enter. Using the Steinhart-Hart equation, the temperature controller converts the thermistor resistance to a displayed temperature. Calibration is more accurate when the data pairs are close to the desired operating temperature. For this example, 25°C is the goal. Calibrating this 10 kΩ thermistor with 10°C, 25°C, and 40°C will offer a wide range of operation as well as 0.01°C accuracy.

Rotate the **Display Select Switch** to **A** and toggle the **Shift Button ON**. A temperature and a resistance will alternate on the display. See the unit of measure LEDs to determine if it is the temperature or resistance value. For the 10 kΩ thermistor in this example, we choose **A**, **B**, and **C** to be (10°C, 19.9 kΩ), (25°C, 10 kΩ), and (40°C, 5.326 kΩ) respectively. This information is available from the thermistor manufacturer (usually in table form). Use the **Digi-Pot Adjust Knob** to change either value when it is displayed. Rotate the **Display Select Switch** to **B** then **C**, making any necessary adjustments.

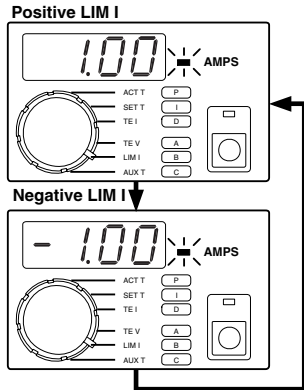

3 Set Limit Current

With the output off, set the limit current below the thermoelectric's maximum current. Assume the example thermoelectric's maximum current is 1.25 Amps. Set the Limit Current to 1.0 Amps. Rotate the **Display Select Switch** to LIM I with the **Shift Button OFF**. The positive and negative limits will alternate on the display. Rotate the **Digi-Pot Adjust Knob** until 1.00 and -1.00 alternate.

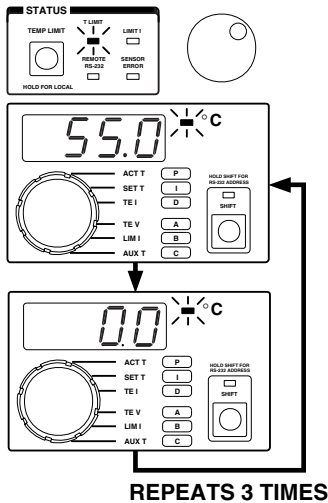

4 Set Temperature Limit

Press and release the **TEMP LIMIT Button**. Two numbers will alternate on the display. If the thermistor temperature exceeds these limits, the output current will be turned off. The numbers will alternate three times before the display reverts to the parameter selected by the **Display Select Switch**, in this case, LIM I. Assume that the load should not be allowed to freeze (0°C) and should not exceed 55°C. Rotate the **Digi-Pot Adjust Knob** until 0°C and 55°C are displayed. The highest temperature is selected as the **High T LIMIT** and the lowest temperature is used as the **Low T LIMIT**.

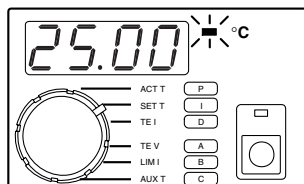

5 Display and Adjust Setpoint Temperature

Rotate the **Display Select Switch** to SET T and toggle the **Shift Button OFF**. The setpoint temperature is displayed. Rotate the **Digi-Pot Adjust Knob** until 25°C is displayed.

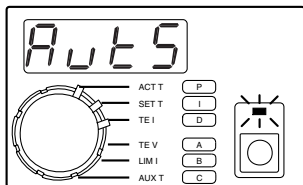

6 Begin Autotune Optimization

Autotune: Rotate the **Display Select Switch** to **P** and toggle the **Shift Button ON**. Use the **Digi-Pot Adjust Knob** to change the value. To begin Autotune optimization, adjust the P value to display AutS or Autd.

AutS: Setpoint Response Autotune Optimization
 Autd: Disturbance Rejection Autotune Optimization

You determine what kind of control loop the Autotune will use based on your settings for the I and D terms. If set to zero, that control term will not be used. The following chart shows which control modes are available and the appropriate I and D settings. Rotate the **Display Select Switch** to **I** then **D**, making any necessary adjustments with the **Digi-Pot Adjust Knob**.

Control Mode:	I	D
PID	non-zero	non-zero
PI	non-zero	OFF = zero
PD	OFF = zero	non-zero
P	OFF = zero	OFF = zero

For this example, adjust **P** to AutS, **I** to 1.0, and **D** to 1.0 .
Manual setting: Adjust **P** to a value other than AutS or Autd.

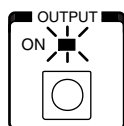

7 Enable the Output Current

Press the **Output Button** to enable the output current and begin the Autotune optimization sequence. The **ON LED** indicator will flash while Autotune optimization is in progress. Once the Autotune sequence is finished, the LFI-3751 will control to the desired operating temperature entered in Step 5. Refer to Chapter 2, Autotune PID operation for more detail.

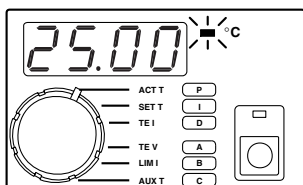

8 Measure Actual Temperature

Rotate the **Display Select Switch** to **ACT T** (**Shift Button OFF**) to monitor the load temperature. **ACT T** temperature now approaches the **SET T** temperature.

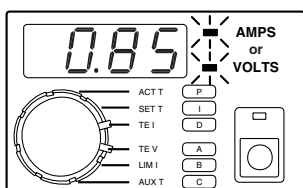

9 Measure Thermoelectric Current and Voltage

Rotate the **Display Select Switch** to **TE I** (**Shift Button OFF**) to monitor the current flowing through the thermoelectric. Rotate the **Display Select Switch** to **TE V** (**Shift Button OFF**) to monitor the voltage across the thermoelectric.





This page intentionally left blank.



Chapter 2: Front Panel Operation



Front Panel Operation

By now, you should be familiar with the Autotune PID feature, how to measure temperature, thermoelectric current & voltage, and how to set various operating parameters. If not, we recommend you read Chapter 1, “Quick Start,” starting on page 13.

This chapter details basic operation with each sensor, how to set limits and control parameters, and how to monitor actual results. Corresponding remote interface commands are briefly noted. Complete RS-232 commands are detailed in Chapter 4.

For sensor configuration, the following notation is used:

A, B, or C refers to the *Display Select Switch* settings. Each sensor type requires different configuration data. The data entered for **A, B, and C** changes for each sensor.

T and **R** refer to Temperature and Resistance data pairs used to characterize resistive sensor’s response to temperature. Subscripts are used when more than one data pair is required.

Slope and **Offset** are used to characterize the non-resistive sensor’s response to temperature changes.

Text in brackets (e.g. **[A1]**) refers to the corresponding RS-232 command.

Autotune PID Operation

The LFI-3751 is capable of automatically characterizing your thermoelectric or resistive heater load and calculating optimum control loop settings for P , I , and D .

1. Autotune Process

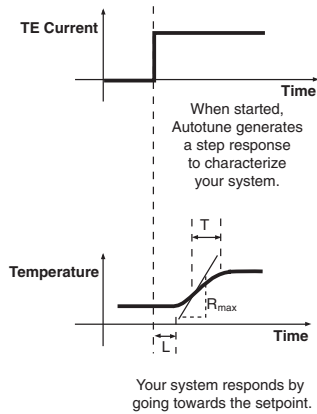

During an Autotune, the LFI-3751 measures the load's thermal lag time, L , the maximum Temperature versus Time slope, R_{max} , and the load's thermal time constant, T , for a given output step current, $TE I$.

The time to complete an Autotune Optimization varies from load to load. The process occurs in three phases:

Phase 1: The LFI-3751 ramps the thermoelectric current to drive the thermal load temperature toward the setpoint temperature.

Phase 2: The LFI-3751 performs three characterization passes.

Phase 3: The LFI-3751 reverts to normal operation, saving the optimized P , I , and D settings in non-volatile memory and settling in at the setpoint temperature.

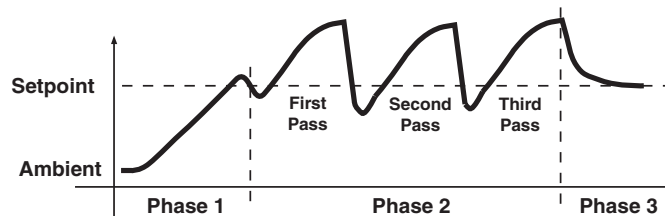

2. Preliminary Considerations

Before performing an Autotune, certain parameters must be set. Here are five items to consider before you start an Autotune sequence.

A. Current Limit Setting

- Make sure the LIM I setting does not exceed the maximum TE I rating for your thermoelectric.
- In Phase 1 of an Autotune sequence, the initial TE current is 10% of the limit current setting. If the ramp rate decreases, the current will be increased in 10% increments to maintain the ramp rate until the load reaches the setpoint temperature.
- The LFI-3751 will display Error 2 (E002) when the temperature setpoint cannot be reached using the TE Current Limit setting.

B. Temperature Limit Setting

- The Autotune sequence will abort if the thermal load temperature exceeds either temperature limit.
- Resolution: While completing the Autotune, reduce the TE Current Limit or if your thermal load can withstand higher or lower temperatures, then increase the Temperature Limit settings.

C. Setpoint Temperature

- Autotune will optimize the control parameters around the setpoint (SET T) that you have selected.
- In temperature mode for thermistors, the controller will capture the information used to calculate the control parameters. When you change your setpoint, the Autotune feature will automatically recalculate the PID terms for the new setpoint.
- If your temperature limits and the SET T temperature are too close (within about 5°C), the sequence will probably reach the temperature limit and abort.

D. If an active device is under temperature control

- Avoid applying power to temperature sensitive devices during the Autotune sequence because extreme temperature fluctuations may occur.
- Apply steady state power to the device for the best Autotune results.

E. Choosing the control loop method

- If you are in an electrically noisy environment, don't use the **D** term. Use only the **P** & **I** terms.
- Generally, it is best to choose **PID** control and let the LFI-3751 determine your control loop method.
- For slow thermal loads that cycle around the setpoint even after **PI** or **PID** Autotune, select **P** or **PD** for the control loop. Note: **P** or **PD** control loops will not settle the load temperature at SET T and will also result in setpoint inaccuracy.

3. Choose an Autotune method

There are two Autotune optimization selections available: **Setpoint Response Tuning** and **Disturbance Rejection Tuning**.

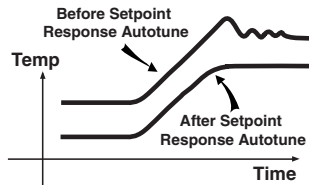

Setpoint Response Tuning is valuable when continuously stepping the LFI-3751 from one temperature to another. Your system will go to temperature quickly and settle in with little or no overshoot.

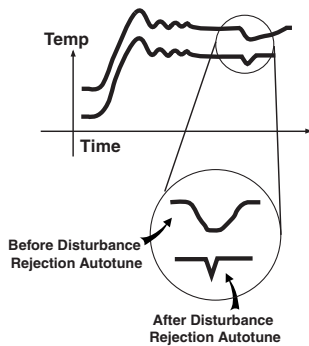

Disturbance Rejection Tuning is valuable when your thermal load is exposed to varied environmental conditions, such as air currents or ambient temperature fluctuations. It also improves temperature stability in applications where the device being temperature controlled experiences significant power or heat transients, such as those found in pulsed laser diode applications.

When a system is optimized for Disturbance Rejection, it is not optimized for Setpoint Response and vice versa. More simply, a thermal load that is optimized to reject disturbances will often overshoot and ring when changing from one setpoint temperature to the next.

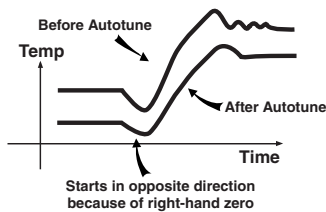

NOTE: Sometimes thermal loads behave in a manner referred to as a “non-minimum phase system” or more simply, the initial response of the system is to move in the opposite direction of the desired temperature change. This effect is caused by a zero in the right-hand plane of the thermal system. When the LFI-3751 performs a Setpoint Response Autotune, it assumes the thermal load is a single pole system. The right-hand plane zero is not compensated for and the load temperature will still overshoot. In most cases where the thermal load exhibits this behavior, the Autotune removes the majority of the overshoot and still improves the settling time performance.

If your thermal load exhibits a non-minimum phase response, do not optimize with Disturbance Rejection Autotuning.

4. Configure LFI-3751 for Autotune

A. Setpoint Response Tuning

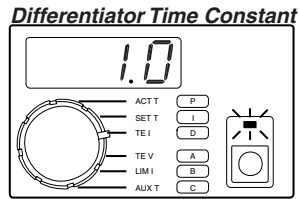
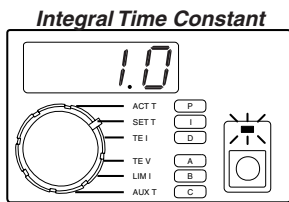
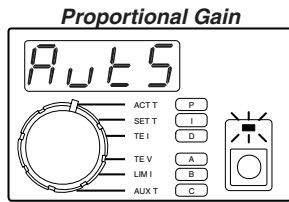
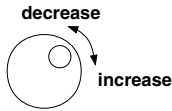

- Rotate the **Display Select Switch** to **P (Shift Button ON)**.
- While the output current is disabled, rotate the **Digi-Pot Adjust Knob** counter-clockwise to change the value displayed to AutS. Wait about two seconds before starting an Autotune sequence.
- Rotate the **Display Select Switch** to **I (Shift Button ON)**.
- Rotate the **Digi-Pot Adjust Knob** to change the value displayed. If $I = 0$, Autotune will optimize your system without an integrator. If $I \neq 0$, Autotune will optimize your system with the integrator function.
- Rotate the **Display Select Switch** to **D (Shift Button ON)**.
- Rotate the **Digi-Pot Adjust Knob** to change the value displayed. If $D = 0$, Autotune will optimize your system without a differentiator. If $D \neq 0$, Autotune will optimize your system with the differentiator function.
- Refer to pages 30 & 31 for a discussion of the integrator and differentiator functions.
- *RS-232 Command:* **[P], [I], [D]**

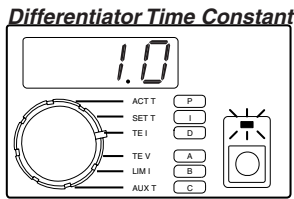
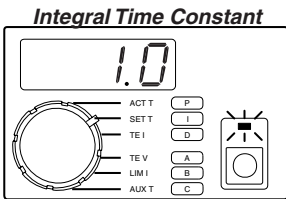
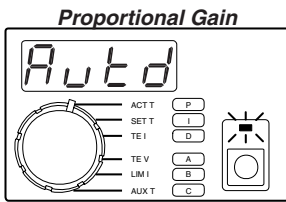
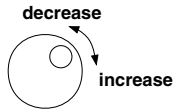

B. Disturbance Rejection Tuning

- Rotate the **Display Select Switch** to **P (Shift Button ON)**.
- While the output current is disabled, rotate the **Digi-Pot Adjust Knob** counter-clockwise to change the value displayed to **Auto**. Wait about two seconds before starting an Autotune sequence.
- Rotate the **Display Select Switch** to **I (Shift Button ON)**.
- Rotate the **Digi-Pot Adjust Knob** to change the value displayed. If $I = 0$, Autotune will optimize your system without an integrator. If $I \neq 0$, Autotune will optimize your system with the integrator function.
- Rotate the **Display Select Switch** to **D (Shift Button ON)**.
- Rotate the **Digi-Pot Adjust Knob** to change the value displayed. If $D = 0$, Autotune will optimize your system without a differentiator. If $D \neq 0$, Autotune will optimize your system with the differentiator function.
- Refer to pages 30 & 31 for a discussion of the integrator and differentiator functions.
- **RS-232 Command:** [P], [I], [D]





5. Start Autotune Optimization

- Prior to enabling current, the thermoelectric and sensor must be wired to the LFI-3751 output connector, and the current and temperature limits must be set.
- Press the **Output Button** to enable current flow and start the Autotune optimization through the thermoelectric (or resistive heater). The **Output LED** will flash green.
- When the Autotune is complete, the unit will beep once and the **Output LED** will light solid green. The new P, I, and D settings are written to non-volatile memory.
- *RS-232 Command:* **[RUN / STOP]**

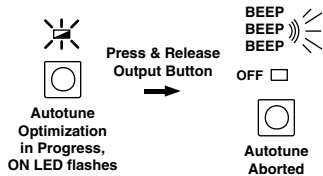

6. Manually Abort Autotune Optimization

- To abort the Autotune, press the **Output Button** once.
- The unit will beep three times.
- The **Output LED** turns off, and current flow is disabled.
- The P, I, and D settings are returned to values set before starting Autotune.

7. Autotune Error Codes

Four error conditions can occur that will abort the Autotune sequence. When an error occurs, the error is displayed as follows. The error is also returned in the [RUN / STOP] RS-232 command:

E001 – Error 1: Zero Value Current Limit Error

- The LFI-3751 detected that either the required positive or negative current limit was set to zero. The LFI-3751 cannot drive the temperature toward the setpoint.
- Correction: Set the limit to something other than zero.

E002 – Error 2: Current Limit Cannot Reach SET T

- The LFI-3751 determined the current limit is not high enough to reach the desired operating temperature entered in SET T.
- Correction: Increase the current limit or review the design to see why the desired temperature differential cannot be achieved.

E003 – Error 3: Non-uniform TE I Step Measured

- It is critical that the step current, TE I, remain constant throughout the Autotune parameter measurements for **L**, **Rmax**, and **T**. If the output current is limited because the compliance voltage of the LFI-3751 has been reached, the step current will not be uniform.
- Correction: Reduce the current limit or use a thermoelectric with a lower voltage requirement.

E004 – Error 4: Zero Slope

- The load temperature is not changing over time. Either the sensor signal is not changing, no current is flowing to the thermoelectric, or even with the maximum current flowing to the thermoelectric the load temperature is not changing.
- Correction: Verify that the sensor is in good thermal contact with the load and that it is properly wired to the LFI Output Connector. Verify that the thermoelectric is properly wired to the LFI Output Connector.



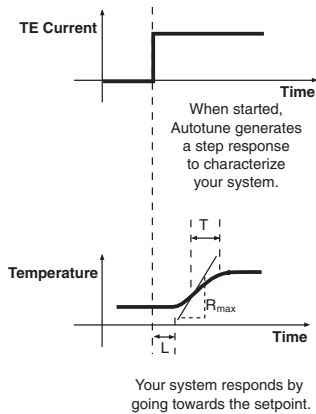

Theory of Autotune PID

1. Proportional Gain – “P” and Autotune Optimization

The proportional gain, P , is measured in Amps Output Current per Volt Error Voltage. The Error Voltage is the difference between the LFI-3751’s Setpoint D to A and the measured sensor voltage feedback. When a difference exists between the setpoint temperature and actual temperature, the proportional gain directs the output power stage to supply an output current that is **proportional** to the difference. Unfortunately, if the Error Voltage drops to zero then so does the output current, which will cause the load temperature to fall back towards ambient. The larger the P value, the closer the proportional gain will settle the load to the desired operating temperature. Likewise, the larger the P value, the greater the tendency to cause temperature overshoot.

L and R_{max} affect the proportional gain setting P . A long thermal lag, L , decreases the proportional gain value. P also decreases when R_{max} , the maximum temperature versus time slope, is large.

Setpoint Response Tuning results in smaller P values than Disturbance Rejection Tuning because lower proportional gains produce less temperature overshoot of the setpoint temperature.

2. Integrator Time Constant – “I” and Autotune Optimization

The integrator time constant, I , is measured in seconds. The integrator function forces the actual temperature to stabilize at the setpoint temperature, something the proportional gain cannot do alone. This is accomplished because the integrator “integrates” the Error Voltage over time. When the actual temperature is far from the setpoint temperature, the integrator charges more quickly since the Error Voltage is large at this point. As the actual temperature approaches the setpoint temperature, the Error Voltage decreases and the integrator charges less quickly until finally the Error Voltage is zero. Once the Error Voltage is zero, the integrator stops charging and controls the output current at the necessary level to maintain a constant load temperature equal to the setpoint temperature.

Some thermal loads oscillate around the setpoint temperature. This oscillation is referred to as thermal cycling. Thermal cycling can occur if the proportional gain is greater than the system’s critical proportional gain or more commonly too small an integrator time constant has been set to compensate for the thermal load’s lag time, L . A small integrator time constant charges more quickly than a larger integrator time constant. If L is significantly larger than the integrator time constant then the integrator will force the output current to shoot past the setpoint temperature since the temperature sensor is lagging behind the thermal load’s actual temperature.

The sensor temperature eventually overshoots the setpoint temperature, forcing the integrator to charge in the opposite direction, reversing the output current. The thermal load's lag causes an overshoot in this direction also and the cycle simply repeats itself. A large enough integrator time constant can be set to compensate for a thermal load's lag time by charging slowly enough to not over-drive the output current. Commonly, temperature controllers will exhibit a damped oscillation when settling to temperature. This occurs because the integrator is set large enough to compensate for the thermal load's lag time but small enough that the integrator must overshoot several times to properly balance the charge on the integrator to deliver the correct output current.

The calculated value of integrated time constant, I , depends on whether the thermal load has been optimized using Setpoint Response or Disturbance Rejection Tuning. Setpoint Response determines I from the thermal load's time constant, T . Disturbance Rejection uses the thermal load's lag time, L , to calculate I . Notice that T is always greater than L and so that Setpoint Response Tuning always calculates a more conservative value of I . Too large a value of I is detrimental when rejecting disturbances because a slower charging integrator will take longer to settle the load's temperature.

3. Differentiator Time Constant – “D” and Autotune Optimization

The differentiator's time constant, D , is also measured in seconds. The differentiator uses the derivative of the Error Voltage versus time to compensate for the proportional gain's and the integrator's tendency to cause the thermal load's temperature to overshoot the setpoint temperature. To understand the differentiator, we must first examine how the proportional gain responds as the load's temperature approaches the setpoint temperature.

As long as the Error Voltage is non-zero, the proportional gain will drive the output to move the thermal load's temperature towards the setpoint temperature. The proportional gain stops driving the output current once the Error Voltage drops to zero (when the load's temperature equals the setpoint temperature). At this point, the load's thermal inertia forces it to overshoot the setpoint temperature. It is not until the Error Voltage reverses polarity that the proportional gain provides an output current that drives the actual temperature back towards the setpoint temperature, which now results in an undershoot condition.

The differentiator is dependent on the slope of Error Voltage versus time and not its magnitude. The faster a load responds, the more the differentiator forces the output current to reduce changes in the Error Voltage. Unlike the proportional gain that moves the load temperature to the setpoint temperature, the differentiator forces the output current to maintain a stable temperature or zero slope whether the load's temperature is at the setpoint temperature or not. Therefore the differentiator produces a “braking” current that resists changes to the thermal load temperature.



Chapter 2 - Front Panel Operation

Theory of Autotune PID

Obviously the differentiator should not be set so high that it counteracts the proportional gain and integrator's attempts to move the load's temperature to the setpoint temperature.

The differentiator time constant is dependent on the thermal load's lag time, L , since this parameter contributes to the integrator overshooting the setpoint temperature. A larger lag time results in a larger calculated D . The differentiator value also depends on the magnitude of proportional gain. A larger proportional gain results in a larger differentiator time constant to compensate for the proportional gain's tendency to cause overshoot.

The Setpoint Response Autotune results in smaller values for D than the Disturbance Rejection. Disturbance Rejection Autotune takes advantage of the differentiator's resistance to temperature variations at the thermal load to suppress the effects of thermal transients.

If your thermal load operates in an **electrically noisy environment**, it might be to your advantage to turn the differentiator off since the differentiator will interpret the resulting fast variations in the Error Voltage incorrectly as thermal load temperature variations. The differentiator can actually cause poorer temperature stability in this instance.

Understanding the Differentiator - A real life analogy

If you still do not understand the differentiator function, fortunately, the LFI-3751 Autotune PID eliminates the need to completely comprehend this control parameter. None the less, this following real life example may give you some insight into the differentiator. Consider the everyday situation of braking a car for a STOP sign. Imagine that the location of the STOP sign is our setpoint temperature and the location of our car is the load temperature. When we are far away from the STOP sign we step on the accelerator to quickly get to the STOP sign. This is exactly what the proportional gain portion of our brain tells us to do since we are far from our destination and want to get there as quickly as possible. The gears in our car are like the current limit function of the LFI-3751, a lower gear limits our acceleration rate towards the STOP sign and a lower current limit setting decreases how much "gas" we can apply and determines how fast we can approach the stop sign. If we did not have a differentiator function in our brain we would not apply the brakes until after we went through the stop sign. For most of us, we stop accelerating our car and begin applying our brakes some distance before we reach the STOP sign. This is exactly how the proportional gain and differentiator work in the PID control loop. Now imagine that the road you are driving on is covered with ice; this corresponds to thermal loads with long thermal lag times. In the case of the icy road we would stop accelerating sooner and apply the brakes for a longer period of time. Remember that a longer thermal lag time results in a smaller proportional time constant and a larger differentiator time constant.



4. Temperature Sensors and Autotune Optimization

Sensor type also affects the magnitude of the proportional gain value calculated when using Autotune optimization. For sensors with high sensitivity (a large change in sensor signal per °C), the resulting proportional gain value will be smaller than if a lower sensitivity sensor were installed into the same thermal load. Correspondingly, the integrator time constant increases when using highly sensitive temperature sensors and the differentiator time constant decreases.

Thermistors are temperature sensors that exhibit high sensitivity and therefore require less proportional gain for optimum performance. Unfortunately, thermistors only perform well over a limited temperature range and their sensor sensitivity is non-linear. This means that thermal loads using thermistors are optimally tuned around one temperature but performance degrades as the setpoint temperature is moved away from the initial tuning temperature. The LFI-3751 compensates for a thermistor's non-linear sensitivity in temperature mode by recalculating the optimum **P**, **I**, and **D** terms whenever the setpoint temperature is changed.

Linear sensors such as the Analog Devices AD590 and National Semiconductor LM335, and Platinum RTDs exhibit poor sensitivity and therefore require considerably higher proportional gains, but do not require recalculation of the PID terms.

5. Thermal load variation and Autotune Optimization

Ideally, we would measure the load's thermal lag time, **L**, the maximum temperature versus time slope, R_{max} , and the load's thermal time constant, **T** for a given output step current, **TE I** at any temperature and achieve the same results. Unfortunately, most thermal loads are only linear over a small range of temperatures.

Several factors cause a thermal load to respond differently from one temperature to another. One such factor is a thermoelectric's efficiency, which varies depending on the current being pumped through the thermoelectric and the temperature difference between its cold and hot plate. At some point, a thermoelectric's heatsink temperature raises to a point where it absorbs heat more slowly from the thermoelectric. Both these factors affect the maximum temperature versus time slope, R_{max} .

Other factors such as ambient temperature change and power being applied to an active device affect the thermal load's lag time, **L**, and time constant, **T**. Fortunately, PID controllers are relatively robust and still control quite well even if they are not optimized. Depending on the size of your load, you may find it good practice to perform a PID Autotune each time the LFI-3751 is powered on to compensate for changes in the thermal load.



This page intentionally left blank.



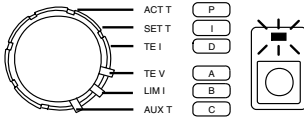

Controlling Temperature with Thermistors

Key to accurately measuring and controlling temperature with a thermistor is properly entering the configuration data. A thermistor's temperature response can be modeled by the Steinhart-Hart equation. To calculate the three Steinhart-Hart coefficients, the LFI-3751 requires three data pairs **A** = (T_1 , R_1), **B** = (T_2 , R_2), and **C** = (T_3 , R_3). Thermistor manufacturers provide this information in a table of Resistance vs. Temperature data. With the Steinhart-Hart equation and coefficients, the LFI-3751 can calculate temperature from thermistor resistance and properly calculate the setpoint resistance from the setpoint temperature.

Default Thermistor Configuration

A	$T_1 = 10.00^\circ\text{C}$ [A1]
	$R_1 = 19.90\text{ k}\Omega$ [A2]
B	$T_2 = 25.00^\circ\text{C}$ [B1]
	$R_2 = 10.00\text{ k}\Omega$ [B2]
C	$T_3 = 40.00^\circ\text{C}$ [C1]
	$R_3 = 5.326\text{ k}\Omega$ [C2]

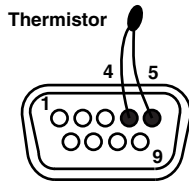

1. Wiring a Thermistor

Wire the thermistor to the **Output Connector** on the rear panel. Shielded cables are available (Wavelength part number CAT-220). Do not exceed 1 meter cable length. Refer to *Sensor Error Condition* on page 55 if you can't clear a Sensor Error.

2. Automatic Bias Current

A fixed bias current, I_{BIAS} , flows from pin 5, through the thermistor and back into pin 4 to produce a voltage, V_T . As the thermistor resistance (R_T) changes, the voltage changes. V_T must be maintained between 0 and +5 V for proper operation. The LFI-3751 automatically ranges between four bias currents (10 μA , 100 μA , 1 mA, and 10 mA) to optimize feedback while allowing a wider temperature range of operation. Hysteresis is designed in to produce "bumpless" operation when switching from one bias current to another.

Thermistor Voltage (pins 5 & 4)

$$V_T = I_{\text{BIAS}} * R_T$$

V_T = Voltage across pins 4 & 5
 I_{BIAS} = LFI-3751 Bias Current
 R_T = Resistance of thermistor

Bias Current and Sensor Resistance

Sensor Current	Resistance Range
10 μA	25 $\text{k}\Omega$ to 500 $\text{k}\Omega$
100 μA	2.5 $\text{k}\Omega$ to 45 $\text{k}\Omega$
1 mA	0.25 $\text{k}\Omega$ to 4.5 $\text{k}\Omega$
10 mA	0 $\text{k}\Omega$ to 0.45 $\text{k}\Omega$

Steinhart-Hart Equation

$$\frac{1}{T} = \chi_1 + \chi_2 \ln(R) + \chi_3 (\ln(R))^3$$

T = Temperature (Kelvin)
 R = Resistance (Ohms)

**Typical Thermistor
 R vs. T response**

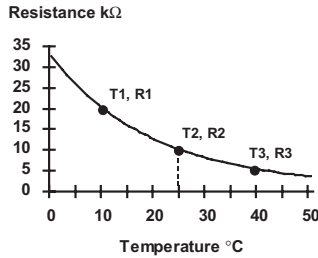

3. Thermistor Temperature vs. Resistance

Temperature can be determined by the Steinhart-Hart equation given the thermistor resistance and the equation coefficients χ_1 , χ_2 , and χ_3 .

To calculate the Steinhart-Hart coefficients, the LFI-3751 needs three (Temperature, Resistance) data pairs. Enter **A**: (T_1 , R_1), **B**: (T_2 , R_2), and **C**: (T_3 , R_3) through the front panel or **[A1]**, **[A2]**, **[B1]**, **[B2]**, **[C1]**, and **[C2]** via the RS-232 interface. Using the thermistor resistance vs. temperature chart provided with your thermistor, select three temperatures. These temperatures can be far apart if you're working with a wide temperature range, or close together to optimize the curve fit around one temperature.

4. Entering Data Pair - A

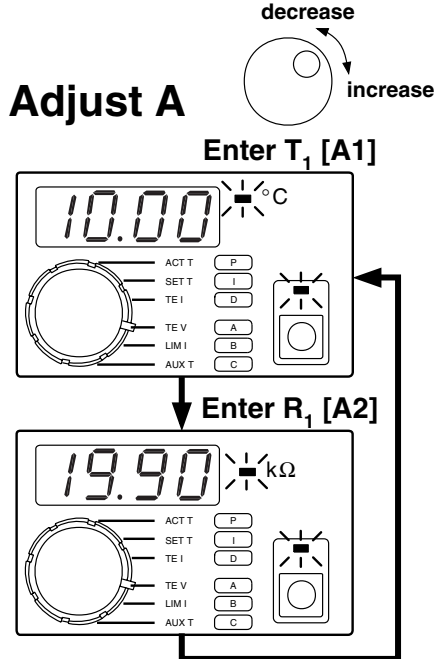

- Rotate the **Display Select Switch** to **A (Shift Button ON)**. The first two data pairs alternate on the display. One is temperature (°C LED lit), the other is the corresponding thermistor resistance (kΩ LED lit).
- Rotate the **Digi-Pot Adjust Knob** to change the value displayed. Default from the factory sets up for a 10 kΩ thermistor (Wavelength part number TCS-610).
- To display thermistor resistance rather than temperature, enter (0.000, 0.000) for the **A** terms. [**B** & **C** are ignored for resistance display.]
- **A, B, and C cannot be adjusted while the output is on.**
- Data pairs **A, B, and C** are saved in non-volatile memory.
- **RS-232 Command:** **[A1] = T₁, [A2] = R₁**

Display Resolution:

Temperature	-199.9 to -20.0°C
	-19.99 to -2.00°C
	-1.999 to 9.999°C
	10.00 to 99.99°C
	100.0 to 199.9°C
Resistance	0 to 9.999 kΩ
	10.00 to 99.99 kΩ
	100.0 to 499.9 kΩ

Adjust B

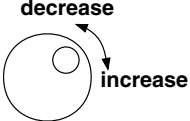
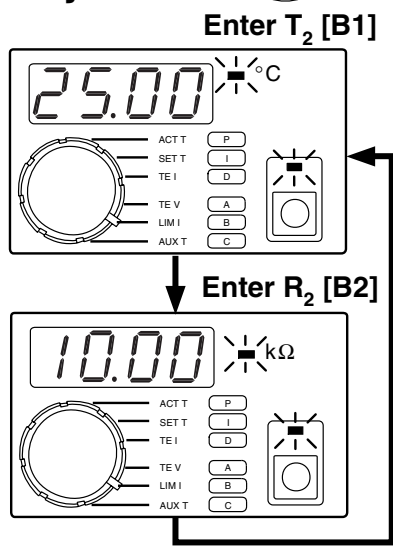
5. Entering Data Pair - B

- Rotate the **Display Select Switch** to **B (Shift Button ON)** to display the second data pair.
- Rotate the **Digi-Pot Adjust Knob** to adjust each value as it is displayed.
- **A, B, and C cannot be adjusted while the output is on.**
- Data pairs **A, B, and C** are saved in non-volatile memory.
- *RS-232 Command:* [B1] = T_2 , [B2] = R_2

Display Resolution:

Temperature	-199.9 to -20.0°C
	-19.99 to -2.00°C
	-1.999 to 9.999°C
	10.00 to 99.99°C
	100.0 to 199.9°C
Resistance	0 to 9.999 kΩ
	10.00 to 99.99 kΩ
	100.0 to 499.9 kΩ

Adjust C

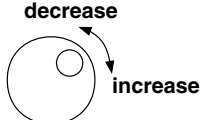
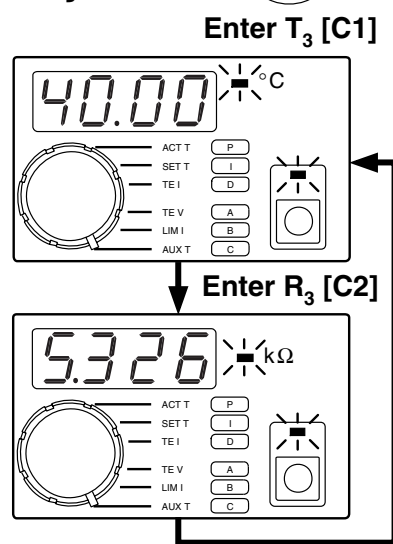
6. Entering Data Pair - C

- Rotate the **Display Select Switch** to **C (Shift Button ON)** to display the third data pair.
- Rotate the **Digi-Pot Adjust Knob** to adjust each value as it is displayed.
- **A, B, and C cannot be adjusted while the output is on.**
- Data pairs **A, B, and C** are saved in non-volatile memory.
- *RS-232 Command:* [C1] = T_3 , [C2] = R_3

Display Resolution:

Temperature	-199.9 to -20.0°C
	-19.99 to -2.00°C
	-1.999 to 9.999°C
	10.00 to 99.99°C
	100.0 to 199.9°C
Resistance	0 to 9.999 kΩ
	10.00 to 99.99 kΩ
	100.0 to 499.9 kΩ

Display Actual Thermistor Temperature

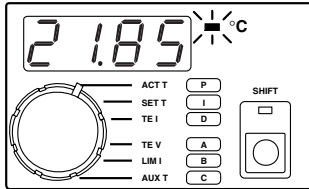

7. Displaying Actual Thermistor Temperature

- Rotate the **Display Select Switch** to **ACT T** (**Shift Button OFF**) to display the thermistor temperature.
- RS-232 Command:** [ACT T]

Display Resolution

-199.9 to -20.0°C
-19.99 to -2.00°C
-1.999 to 9.999°C
10.00 to 99.99°C
100.0 to 199.9°C

Display Actual Thermistor Resistance

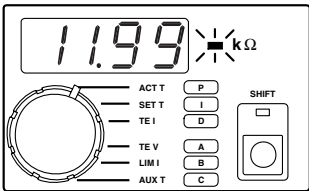

8. Displaying Actual Thermistor Resistance

- Enter [0.000, 0.000] for **A** to have the LFI-3751 display thermistor resistance (kΩ) when the **Display Select Switch** is rotated to **ACT R** (**Shift Button OFF**).
- RS-232 Command:** [ACT R]

Display Resolution

0 to 9.999 kΩ
10.00 to 99.99 kΩ
100.0 to 499.9 kΩ

Display Setpoint Temperature

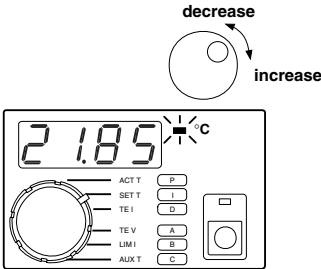

9. Adjusting Thermistor Temperature Setpoint

- Rotate the **Display Select Switch** to **SET T** (**Shift Button OFF**). Temperature will be displayed.
- To adjust the setpoint, rotate the **Digi-Pot Adjust Knob**. While the knob is rotating, the display will change, but the instrument will not control to the new setpoint until the knob stops moving.
- The decimal point will move to display maximum resolution.
- SET T** is saved in non-volatile memory.
- RS-232 Command:** [SET T]

Display Setpoint Resistance

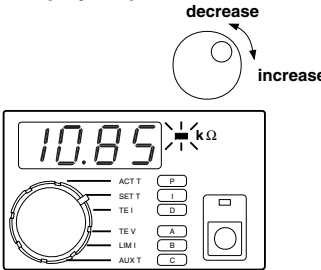

10. Adjusting Thermistor Resistance Setpoint

- Rotate the **Display Select Switch** to **SET R** (**Shift Button OFF**). If (0.000, 0.000) has been entered for **A**, resistance will be displayed.
- To adjust the setpoint, rotate the **Digi-Pot Adjust Knob**. While the knob is rotating, the display will change, but the instrument will not control to the new setpoint until the knob stops moving.
- The decimal point will move to display maximum resolution.
- SET R** is saved in non-volatile memory.
- Temperature Limits are disabled in Resistive Operating Mode.
- RS-232 Command:** [SET R]

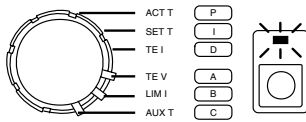

Controlling Temperature with RTDs

Key to accurately measuring and controlling temperature with an RTD is properly entering the configuration data. An RTD's temperature response can be assumed to be linear or more precisely modeled by the Callendar - Van Dusen Curve fit. To indicate that the sensor is an RTD, **A** = (1.000, 1.000). To calculate the linear or Callendar - Van Dusen coefficients, the LFI-3751 requires two data pairs **B** = (T_2 , R_2), **C** = (T_3 , R_3). With the appropriate equation and coefficients, the LFI-3751 can calculate temperature from RTD resistance and properly calculate the setpoint resistance from the setpoint temperature.

Default RTD Configuration

A	= 1.000	[A1]
	= 1.000	[A2]
B	$T_1 = 0.00^\circ\text{C}$	[B1]
	$R_1 = 0.100 \text{ k}\Omega$	[B2]
C	$T_2 = 100.00^\circ\text{C}$	[C1]
	$R_2 = 0.139 \text{ k}\Omega$	[C2]

2 wire RTD

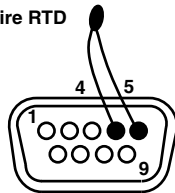

1. Wiring an RTD

Wire the RTD to the **Output Connector** on the rear panel. Shielded cables are available (Wavelength part number CAT-220). Do not exceed 1 meter cable length. Refer to *Sensor Error Condition* on page 55 if you can't clear a Sensor Error.

3 wire RTD

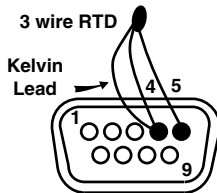

2. Automatic Bias Current

A fixed bias current, I_{BIAS} , flows from pin 5, through the RTD and back into pin 4 to produce a voltage, V_{RTD} . As the RTD resistance (R_{RTD}) changes, the voltage changes. The voltage must be between 0 and +5 V for proper operation. The LFI-3751 automatically ranges between four bias currents (10 μA , 100 μA , 1 mA, and 10 mA) to optimize the feedback while allowing a wider temperature range of operation. Hysteresis is designed in to produce "bumpless" operation when switching from one bias current to another.

RTD Voltage (pins 5 & 4)

$$V_{\text{RTD}} = I_{\text{BIAS}} * R_{\text{RTD}}$$

V_{RTD} = Voltage across pins 4 & 5

I_{BIAS} = LFI-3751 Bias Current

R_{RTD} = Resistance of RTD

Bias Current and Sensor Resistance

Sensor Current	Resistance Range
10 μA	25 $\text{k}\Omega$ to 500 $\text{k}\Omega$
100 μA	2.5 $\text{k}\Omega$ to 45 $\text{k}\Omega$
1 mA	0.25 $\text{k}\Omega$ to 4.5 $\text{k}\Omega$
10 mA	0 $\text{k}\Omega$ to 0.45 $\text{k}\Omega$

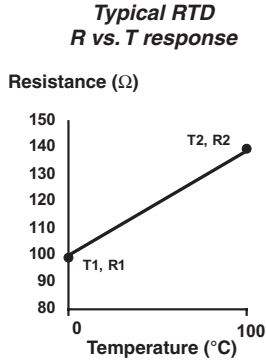

3. RTD Temperature vs. Resistance

The LFI-3751 uses three data pairs to configure an RTD- **A**, **B**, and **C**. To indicate you're using an RTD, the first data pair **A** must be (1.000, 1.000). Enter **A**: (1.000, 1.000), **B**: (T_1, R_1), and **C**: (T_2, R_2) through the front panel or **[A1]**, **[A2]**, **[B1]**, **[B2]**, **[C1]**, and **[C2]** via the RS-232 interface. RTD resistance changes almost linearly with temperature. Depending on your need for accuracy, the LFI-3751 offers two methods for modeling RTDs: *Linear* or *Callendar - Van Dusen Curve fit*.

Linear Configuration Constants **Linear RTD Configuration**

$$R_0 = R_2 - \frac{(R_2 - R_1)}{(T_2 - T_1)} * T_2$$

$$\text{alpha} = a = \frac{(R_2 - R_1)}{R_0 * (T_2 - T_1)}$$

R_0 = RTD Resistance at 0°C
 (T_1, R_1) & (T_2, R_2) = **B** & **C** entries
 alpha = Normalized ΔR vs.
 Temperature

The first method assumes the RTD temperature response to be linear. Enter two (Temperature, Resistance) data pairs **B**: (T_1, R_1) and **C**: (T_2, R_2). R_0 (resistance at 0°C) and alpha are calculated to derive temperature from the measured RTD resistance, R_{RTD} . All resistances are in ohms and T is in °C. *Note that R_0 is typically the resistance the RTD is known by: i.e. a "100 Ω RTD" is usually 100 Ω at 0°C.*

Linear Temperature Calculation

$$T_{RTD} = \frac{(R_{RTD} - R_0)}{R_0 * \text{alpha}}$$

R_0 = RTD Resistance at 0°C
 R_{RTD} = Resistance of RTD
 T_{RTD} = Temperature of RTD
 alpha = Normalized ΔR vs.
 Temperature

Callendar - Van Dusen Curve Fit RTD Configuration

Callendar - Van Dusen Curve Fit

$$R_T = R_0 (1 + \beta_1 T + \beta_2 T^2 + \beta_3 (T - 100)^3)$$

R_0 = RTD Resistance at 0°C
 R_T = Resistance of RTD
 T = Temperature of RTD
 $\beta_1, \beta_2, \beta_3$ = Callendar - Van Dusen coefficients

For more accuracy, the RTD response can be approximated by the Callendar-Van Dusen curve fit. Most platinum RTDs follow one of three standardized curves, the DIN 43760 standard, the U.S. Industrial or American standard, or the International Temperature Scale that is used with wire-wound RTDs. The following table lists the coefficients for these three platinum RTDs.

Callendar - Van Dusen Coefficients

Standard	Alpha	β_1	β_2	β_3	Φ
DIN 43760	0.003850	3.908×10^{-3}	-5.8019×10^{-7}	-4.2735×10^{-12}	1.39
American	0.003911	3.9692×10^{-3}	-5.8495×10^{-7}	-4.2325×10^{-12}	1.40
ITS-90	0.003926	3.9848×10^{-3}	-5.87×10^{-7}	-4.0×10^{-12}	1.41

To use these coefficients, rather than the linear configuration, certain values must be entered for **B** and **C**. The LFI-3751 will use the Callendar Van-Dusen coefficients if $T_1 = 0^\circ\text{C}$, $T_2 = 100^\circ\text{C}$, and $R_2 = \Phi R_1$. Φ is listed in the table above. The following table shows what should be entered for a 100 Ω RTD that follows each of the standardized curves.

Example Entries for three different standard 100 Ω RTDs

Standard	B		C	
	T_1 or [B1]	R_1 or [B2]	T_2 or [C1]	R_2 or [C2]
DIN 43760	0°C	0.100 k Ω	100°C	0.139 k Ω
American	0°C	0.100 k Ω	100°C	0.140 k Ω
ITS-90	0°C	0.100 k Ω	100°C	0.141 k Ω

Calculate Temperature from Resistance, Callendar - Van Dusen Curve Fit

$$T = \frac{-\beta_1 R_1 + \sqrt{(\beta_1 R_1)^2 - 4 \beta_2 R_1 (R_1 - R_{RTD})}}{2 \beta_2 R_1}$$

R_1 = RTD Resistance at 0°C
 R_{RTD} = Resistance of RTD
 T = Temperature of RTD

Temperature will be calculated using the first two coefficients (β_1 & β_2). Coefficient β_3 is not used, but its absence does not introduce considerable error.



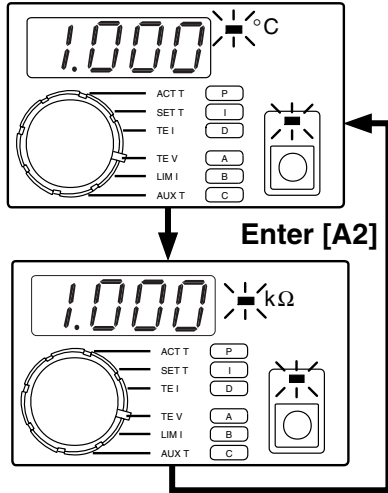
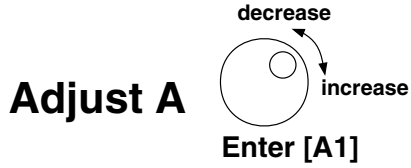

4. Entering Data Pair - A

- Rotate the **Display Select Switch** to **A (Shift Button ON)**. The first two data pairs alternate on the display. (1.000, 1.000) indicates to the LFI-3751 that you're using an RTD.
- Rotate the **Digi-Pot Adjust Knob** to change the value displayed.
- **A, B, and C cannot be adjusted while the output is on.**
- Data pairs **A, B, and C** are saved in non-volatile memory.
- **RS-232 Command:** [A1] = +001.000, [A2] = +001.000

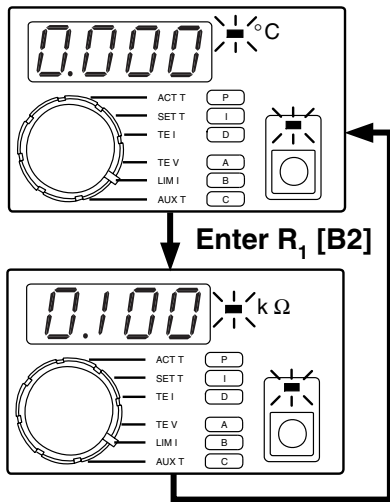
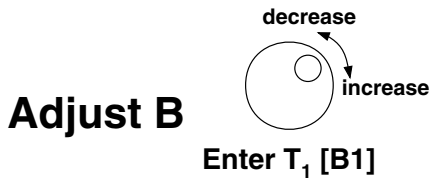

5. Entering Data Pair - B

- Rotate the **Display Select Switch** to **B (Shift Button ON)** to display the second data pair.
- Rotate the **Digi-Pot Adjust Knob** to adjust each value as it is displayed. Default from the factory sets up for a 100 Ω RTD using the DIN 43760 coefficients.
- To display RTD resistance rather than temperature, enter (0.000, 0.000) for the **B** terms. [**C** terms are ignored for resistance display.]
- **A, B, and C cannot be adjusted while the output is on.**
- Data pairs **A, B, and C** are saved in non-volatile memory.
- **RS-232 Command:** [B1] = T₁, [B2] = R₁

Display Resolution:

Temperature	-199.9 to -20.0°C
	-19.99 to -2.00°C
	-1.999 to 9.999°C
	10.00 to 99.99°C
Resistance	100.0 to 199.9°C
	0 to 9.999 kΩ
	10.00 to 99.99 kΩ
	100.0 to 499.9 kΩ

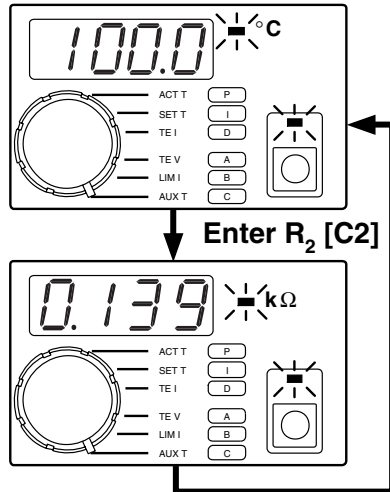
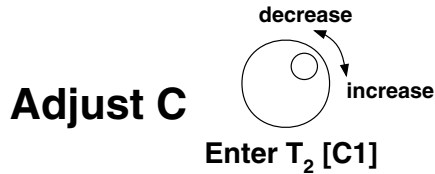

6. Entering Data Pair - C

- Rotate the **Display Select Switch** to **C** (**Shift Button ON**) to display the third data pair.
- Rotate the **Digi-Pot Adjust Knob** to adjust each value as it is displayed.
- **A, B, and C cannot be adjusted while the output is on.**
- Data pairs **A, B, and C** are saved in non-volatile memory.
- **RS-232 Command:** [C1] = T_2 , [C2] = R_2

Display Resolution:

Temperature	-199.9 to -20.0°C
	-19.99 to -2.00°C
	-1.999 to 9.999°C
	10.00 to 99.99°C
	100.0 to 199.9°C
Resistance	0 to 9.999 kΩ
	10.00 to 99.99 kΩ
	100.0 to 499.9 kΩ

Display Actual RTD Temperature

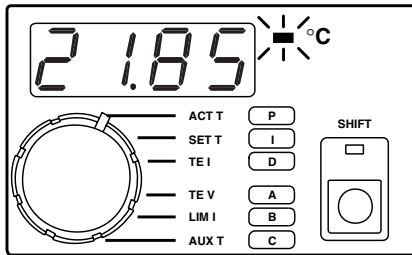

7. Displaying Actual RTD Temperature

- Rotate the **Display Select Switch** to **ACT T** (**Shift Button OFF**) to display the RTD temperature.
- **RS-232 Command:** [ACT T]

Display Resolution:

-199.9 to -20.0°C
-19.99 to 99.99°C
100.0 to 199.9°C

Display Actual RTD Resistance

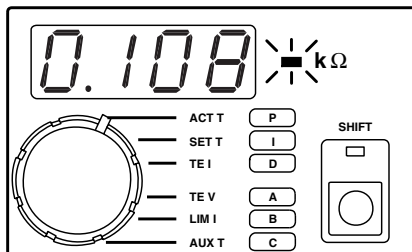

8. Displaying Actual RTD Resistance

- Enter (1.000, 1.000) for **A** and (0.000, 0.000) for **B** to have the LFI-3751 display RTD resistance (kΩ) when the **Display Select Switch** is rotated to **ACT T** (**Shift Button OFF**).
- **RS-232 Command:** [ACT R]

Display Resolution:

0 to 9.999 kΩ
10.00 to 99.99 kΩ
100.0 to 499.9 kΩ



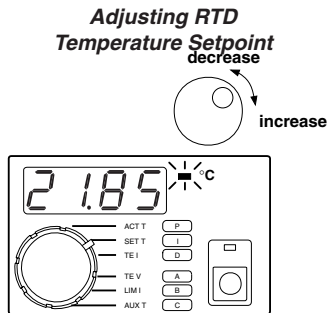

9. Adjusting RTD Temperature Setpoint

- Rotate the **Display Select Switch** to **SET T (Shift Button OFF)**. Temperature will be displayed.
- To adjust the setpoint, rotate the **Digi-Pot Adjust Knob**. While the knob is rotating, the display will change, but the instrument will not control to the new setpoint until the knob stops moving.
- The decimal point will move to display maximum resolution.
- **SET T** is saved in non-volatile memory.
- **RS-232 Command: [SET T]**

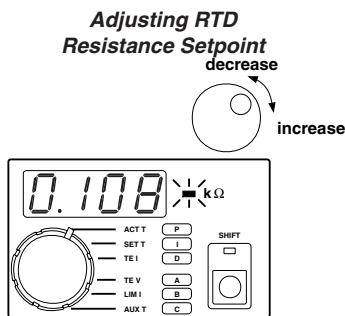

10. Adjusting RTD Resistance Setpoint

- Rotate the **Display Select Switch** to **SET T (Shift Button OFF)**. If (1.000, 1.000) has been entered for **A** and (0.000, 0.000) has been entered for **B**, resistance will be displayed.
- To adjust the setpoint, rotate the **Digi-Pot Adjust Knob**. While the knob is rotating, the display will change, but the instrument will not control to the new setpoint until the knob stops moving.
- The decimal point will move to display maximum resolution.
- **SET R** is saved in non-volatile memory.
- Temperature Limits are disabled in Resistive Operating Mode.
- **RS-232 Command: [SET R]**

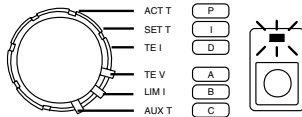

Default AD590 Configuration

A	= 2.000	[A1]
	= 2.000	[A2]
B	Slope = 1.000 $\mu\text{A} / \text{K}$	[B1]
C	Offset = 0.00 μA	[C1]

Controlling Temperature with an AD590

Key to accurately measuring and controlling temperature with an AD590 is properly entering the configuration data. An AD590 is a current source with an output current that varies linearly with temperature. To indicate to the LFI-3751 that the sensor is an AD590, **A** = (2.000, 2.000). To characterize the linear response, the LFI-3751 requires a **Slope** and **Offset**. For the AD590, **B** = **Slope** and **C** = **Offset**. With this information, the LFI-3751 can calculate temperature from AD590 current and properly calculate the setpoint current from the setpoint temperature.

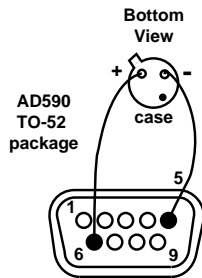

1. Wiring an AD590

Wire the AD590 to the **Output Connector** on the rear panel. Shielded cables are available (Wavelength part number CAT-220). Do not exceed 1 meter cable length. Refer to *Sensor Error Condition* on page 55 if you can't clear a Sensor Error.

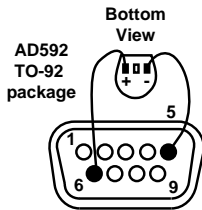

2. Temperature vs. AD590 Current

An AD590 is a current source with an output current that varies linearly with temperature. The LFI-3751 requires a **Slope** and **Offset** to model this response mathematically. To indicate you're using an AD590, **A** = (2.000, 2.000). To configure its response, **B** = **Slope**, and **C** = **Offset**. Typically the **Slope** is 1 $\mu\text{A} / \text{Kelvin}$ and the **Offset** is 0 μA .

$$T = \frac{I_{AD590} - b_{AD590}}{m_{AD590}} - 273.15$$

T = AD590 Temperature ($^{\circ}\text{C}$)
 I_{AD590} = AD590 Current
 m_{AD590} = AD590 **Slope**
 b_{AD590} = AD590 **Offset**

Enter **A**: (2.000, 2.000), **B**: **Slope**, and **C**: **Offset** through the front panel or **[A1]**, **[A2]**, **[B1]**, and **[C1]** via the RS-232 interface.



Adjust A

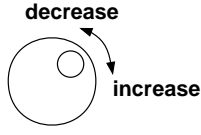

Enter [A1]

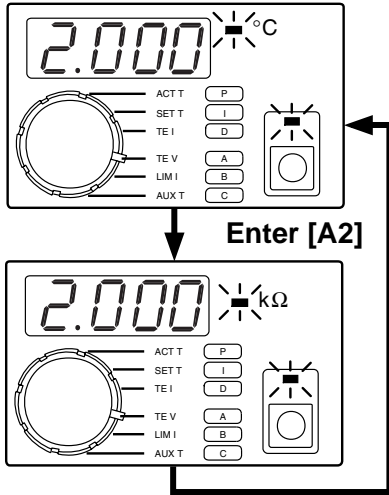

3. Entering Data Pair - A

- Rotate the **Display Select Switch** to **A (Shift Button ON)**. The first two data pairs alternate on the display. (2.000, 2.000) indicates to the LFI-3751 that you're using an AD590.
- Rotate the **Digi-Pot Adjust Knob** to change the value displayed.
- **A, B, and C cannot be adjusted while the output is on.**
- Data for **A, B, and C** are saved in non-volatile memory.
- **RS-232 Command:** [A1] = +002.000, [A2] = +002.000

Adjust B

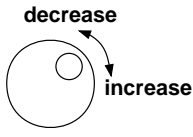

Enter Slope [B1]

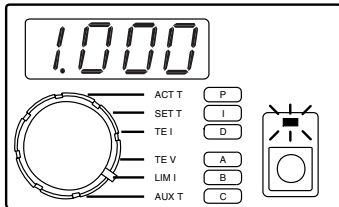

4. Entering Data Point - B

- Rotate the **Display Select Switch** to **B (Shift Button ON)** to display the AD590's **Slope** in $\mu\text{A} / \text{Kelvin}$.
- Rotate the **Digi-Pot Adjust Knob** to change the value. Default from the factory sets up for a $1 \mu\text{A} / \text{Kelvin}$ slope.
- **A, B, and C cannot be adjusted while the output is on.**
- Data for **A, B, and C** are saved in non-volatile memory.
- **RS-232 Command:** [B1] = Slope

Display Resolution:

Slope 0.100 to 9.999 $\mu\text{A} / \text{K}$

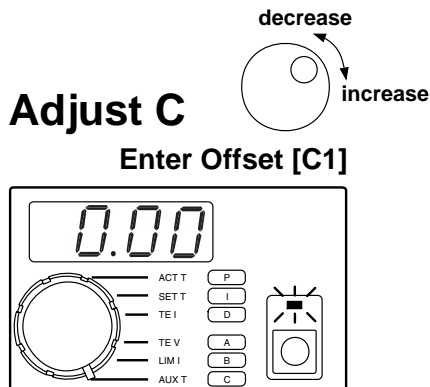

5. Entering Data Point - C

- Rotate the **Display Select Switch** to **C (Shift Button ON)** to display the AD590 Offset in μA .
- Rotate the **Digi-Pot Adjust Knob** to change the value. Factory default is $0 \mu\text{A}$.
- **A, B, and C cannot be adjusted while the output is on.**
- Data pairs **A, B, and C** are saved in non-volatile memory.
- **RS-232 Command: [C1] = Offset**

Display Resolution:

Offset -9.99 to 9.99 μA

Display Actual AD590 Temperature

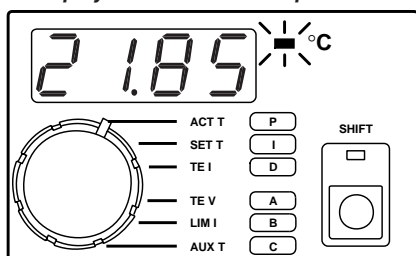

6. Displaying Actual AD590 Temperature

- Rotate the **Display Select Switch** to **ACT T (Shift Button OFF)** to display the AD590 temperature.
- **RS-232 Command: [ACT T]**

Display Resolution:

-199.9 to -20.0°C
-19.99 to 99.99°C
100.0 to 199.9°C

Display AD590 Setpoint Temperature

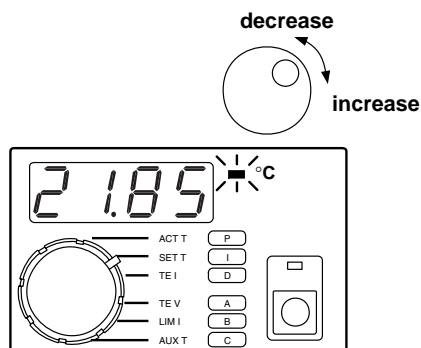

7. Adjusting AD590 Temperature Setpoint

- Rotate the **Display Select Switch** to **SET T (Shift Button OFF)**. Temperature will be displayed.
- To adjust the setpoint, rotate the **Digi-Pot Adjust Knob**. While the knob is rotating, the display will change, but the instrument will not control to the new setpoint until the knob stops moving.
- The decimal point will move to display maximum resolution.
- **SET T** is saved in non-volatile memory.
- **RS-232 Command: [SET T]**

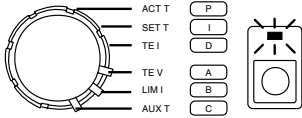

Controlling Temperature with an LM335

Key to accurately measuring and controlling temperature with an LM335 is properly entering the configuration data. An LM335 produces a voltage that changes linearly with temperature. To indicate to the LFI-3751 that the sensor is an LM335, **A** = (3.000, 3.000). To characterize the linear response, the LFI-3751 requires a **Slope** and **Offset**. For the LM335, **B** = **Slope** and **C** = **Offset**. With this information, the LFI-3751 can calculate temperature from LM335 voltage and properly calculate the setpoint voltage from the setpoint temperature.

Default LM335 Configuration

A	= 3.000	[A1]
	= 3.000	[A2]
B	Slope = 10.00 mV / K	[B1]
C	Offset = 0.0 mV	[C1]

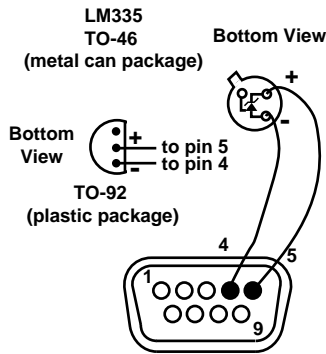

1. Wiring an LM335

Wire the LM335 to the **Output Connector** on the rear panel. Shielded cables are available (Wavelength part number CAT-220). Do not exceed 1 meter cable length. Refer to *Sensor Error Condition* on page 55 if you can't clear a Sensor Error.

LM335 Temperature

$$T = \frac{V_{LM335} - b_{LM335}}{m_{LM335}} - 273.15$$

T = LM335 Temperature (°C)

V_{LM335} = Voltage across pins 4 & 5

m_{LM335} = LM335 **Slope** =
10 mV / Kelvin

b_{LM335} = LM335 **Offset** = 0 mV

2. Temperature vs. LM335 Voltage

The LM335 produces a voltage that changes linearly with temperature in Kelvin. The LFI-3751 requires a **Slope** and **Offset** to model this response mathematically. To indicate you're using an LM335, **A** = (3.000, 3.000). To configure the response, **B** = **Slope** and **C** = **Offset**.

Enter **A**: (3.000, 3.000), **B**: **Slope**, and **C**: **Offset** through the front panel or **[A1]**, **[A2]**, **[B1]**, and **[C1]** via the RS-232 interface.

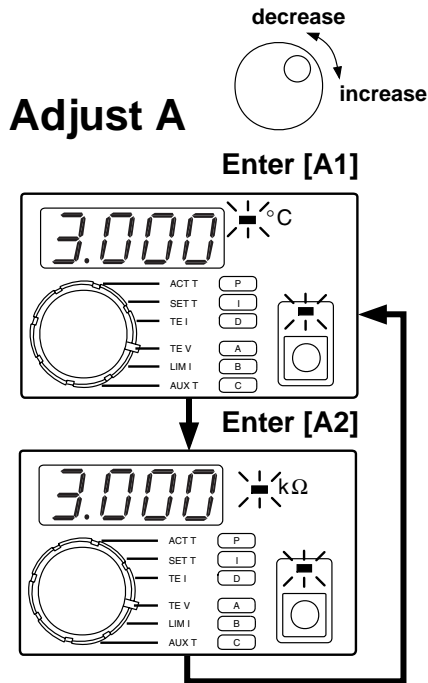

3. Entering Data Pair - A

- Rotate the *Display Select Switch* to **A** (*Shift Button ON*). The first two data pairs alternate on the display. (3.000, 3.000) indicates to the LFI-3751 that you're using an LM335.
- Rotate the *Digi-Pot Adjust Knob* to change the value displayed.
- **A, B, and C cannot be adjusted while the output is on.**
- Data for **A, B, and C** are saved in non-volatile memory.
- *RS-232 Command*: [A1] = +003.000, [A2] = +003.000

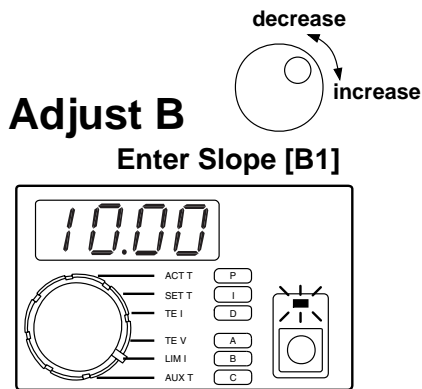

4. Entering Data Point - B

- Rotate the *Display Select Switch* to **B** (*Shift Button ON*) to display the **Slope** in mV / Kelvin.
- Rotate the *Digi-Pot Adjust Knob* to change the value. Default from the factory sets up for a 10 mV / Kelvin slope.
- **A, B, and C cannot be adjusted while the output is on.**
- Data for **A, B, and C** are saved in non-volatile memory.
- *RS-232 Command*: [B1] = Slope

Display Resolution:

Slope	1.00 to 20.00 mV / K
-------	----------------------



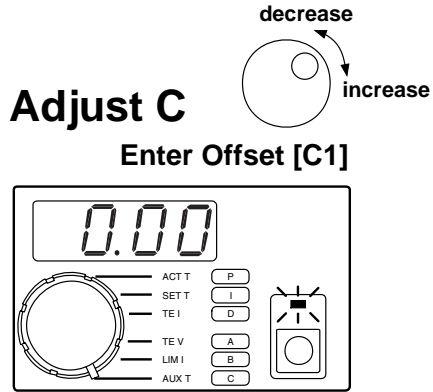

5. Entering Data Point - C

- Rotate the **Display Select Switch** to **C (Shift Button ON)** to display the **Offset** in mV. For the LM335, **Offset** is 0 mV.
- Rotate the **Digi-Pot Adjust Knob** to change the value. Default from the factory sets up for a 0 mV offset.
- **A, B, and C cannot be adjusted while the output is on.**
- Data pairs **A, B, and C** are saved in non-volatile memory.
- **RS-232 Command: [C1] = Offset**

Display Resolution:

Offset	-9.99 to 9.99 mV
--------	------------------

Display Actual LM335 Temperature

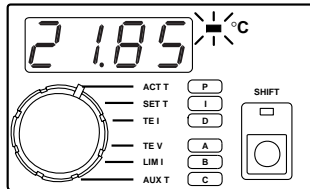

6. Displaying Actual LM335 Temperature

- Rotate the **Display Select Switch** to **ACT T (Shift Button OFF)** to display the LM335 temperature.
- **RS-232 Command: [ACT T]**

Display Resolution:

-199.9 to -20.0°C
-19.99 to 99.99°C
100.0 to 199.9°C

Display Setpoint Temperature

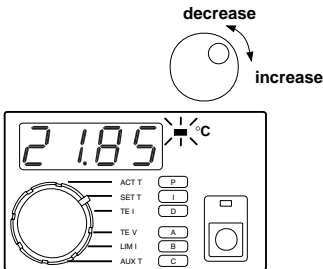

7. Adjusting LM335 Temperature Setpoint

- Rotate the **Display Select Switch** to **SET T (Shift Button OFF)**. Temperature will be displayed.
- To adjust the setpoint, rotate the **Digi-Pot Adjust Knob**. While the knob is rotating, the display will change, but the instrument will not control to the new setpoint until the knob stops moving.
- The decimal point will move to display maximum resolution.
- **SET T** is saved in non-volatile memory.
- **RS-232 Command: [SET T]**

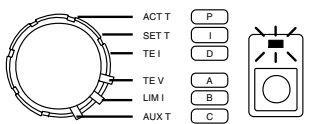

Controlling Temperature with an LM35

Key to accurately measuring and controlling temperature with an LM35 is properly entering the configuration data. An LM35 produces a voltage that changes linearly with temperature. To indicate to the LFI-3751 that the sensor is an LM35, **A** = (4.000, 4.000). To characterize the linear response, the LFI-3751 requires a **Slope** and **Offset**. For the LM35, **B** = **Slope** and **C** = **Offset**. With this information, the LFI-3751 can calculate temperature from LM35 voltage and properly calculate the setpoint voltage from the setpoint temperature.

Default LM35 Configuration

A	= 4.000	[A1]
	= 4.000	[A2]
B	Slope = 10.00 mV / °C	[B1]
C	Offset = 0.0 mV	[C1]

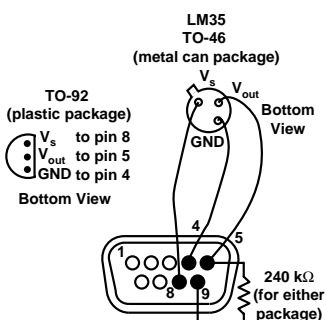

1. Wiring an LM35

Wire the LM35 to the **Output Connector** on the rear panel. Shielded cables are available (Wavelength part number CAT-220). Do not exceed 1 meter cable length. Refer to *Sensor Error Condition* on page 55 if you can't clear a Sensor Error.

2. Temperature vs. LM35 Voltage

The LM35 produces a voltage that changes linearly with temperature in Celcius. The LFI-3751 requires a **Slope** and **Offset** to model this response mathematically. To indicate you're using an LM35, **A** = (4.000, 4.000). To configure the response, **B** = **Slope** and **C** = **Offset**.

LM35 Temperature

$$T = \frac{V_{LM35} - b_{LM35}}{m_{LM35}}$$

T = LM35 Temperature (°C)
 V_{LM35} = Voltage across pins 4 & 5
 m_{LM35} = LM35 **Slope** = 10 mV / °C
 b_{LM35} = LM35 **Offset** = 0 mV

Enter **A**: (4.000, 4.000), **B**: **Slope**, and **C**: **Offset** through the front panel or **[A1]**, **[A2]**, **[B1]**, and **[C1]** via the RS-232 interface.



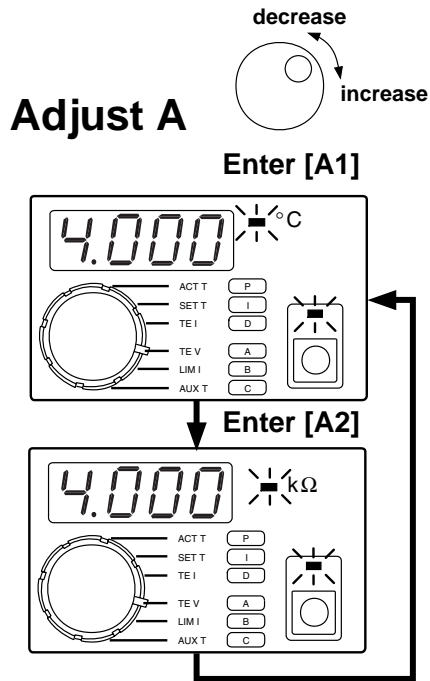

3. Entering Data Pair - A

- Rotate the **Display Select Switch** to **A (Shift Button ON)**. The first two data pairs alternate on the display. (4.000, 4.000) indicates to the LFI-3751 that you're using an LM35.
- Rotate the **Digi-Pot Adjust Knob** to change the value displayed.
- **A, B, and C cannot be adjusted while the output is on.**
- Data for **A, B, and C** are saved in non-volatile memory.
- **RS-232 Command:** [A1] = +004.000, [A2] = +004.000

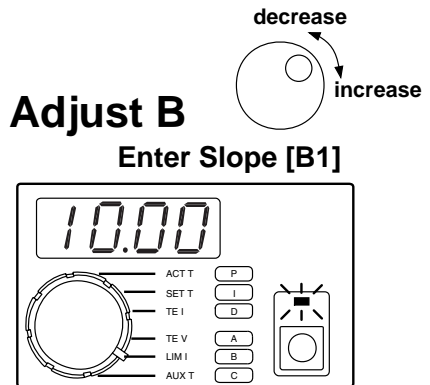

4. Entering Data Point - B

- Rotate the **Display Select Switch** to **B (Shift Button ON)** to display the **Slope** in mV / °C.
- Rotate the **Digi-Pot Adjust Knob** to change the value. Default from the factory sets up for a 10 mV / °C slope.
- **A, B, and C cannot be adjusted while the output is on.**
- Data for **A, B, and C** are saved in non-volatile memory.
- **RS-232 Command:** [B1] = Slope

Display Resolution:

Slope 1.00 to 20.00 mV / °C

Adjust C
 Enter Offset [C1]

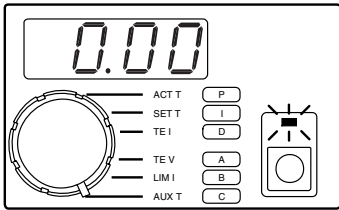
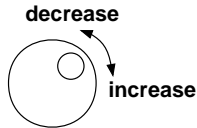

5. Entering Data Point - C

- Rotate the **Display Select Switch** to **C (Shift Button ON)** to display the **Offset** in mV. For the LM35, **Offset** is 0 mV.
- Rotate the **Digi-Pot Adjust Knob** to change the value. Default from the factory sets up for a 0 mV offset.
- **A, B, and C cannot be adjusted while the output is on.**
- Data pairs **A, B, and C** are saved in non-volatile memory.
- *RS-232 Command: [C1] = Offset*

Display Resolution:

Offset	-9.99 to 9.99 mV
--------	------------------

Display Actual LM35 Temperature

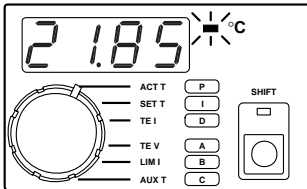

6. Displaying Actual LM35 Temperature

- Rotate the **Display Select Switch** to **ACT T (Shift Button OFF)** to display the LM35 temperature.
- *RS-232 Command: [ACT T]*

Display Resolution:

-199.9 to -20.0°C
-19.99 to 99.99°C
100.0 to 199.9°C

Display Setpoint Temperature

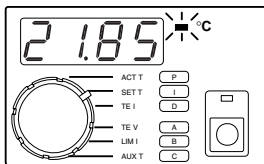
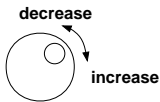

7. Adjusting LM35 Temperature Setpoint

- Rotate the **Display Select Switch** to **SET T (Shift Button OFF)**. Temperature will be displayed.
- To adjust the setpoint, rotate the **Digi-Pot Adjust Knob**. While the knob is rotating, the display will change, but the instrument will not control to the new setpoint until the knob stops moving.
- The decimal point will move to display maximum resolution.
- **SET T** is saved in non-volatile memory.
- *RS-232 Command: [SET T]*





This page intentionally left blank.



Sensor Error Condition

Sensor Error Process

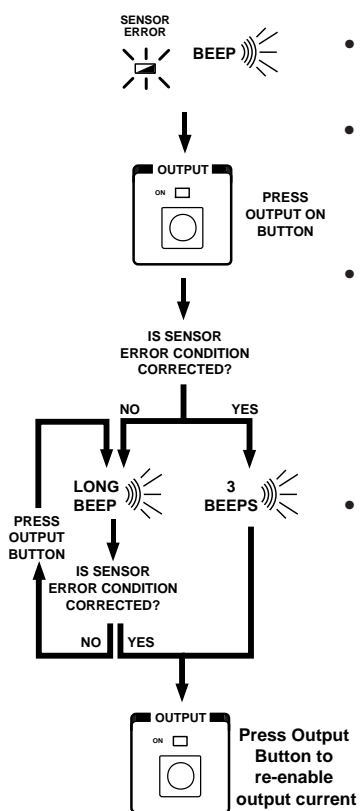

- The **Sensor Error LED** flashes red and the unit beeps whenever the sensor error condition occurs. The output is forced OFF.
- If you correct the error condition then press the **Output Button** to clear the error, the instrument will beep three times to indicate that the error is cleared. Once the error is cleared, press the **Output Button** to re-enable the current.
- If the error condition has not been corrected, when you press the **Output Button** to clear the error, the instrument will sound one long beep. As long as the error condition has not been corrected, pressing the **Output Button** will produce the long beep. If the error condition is corrected, when you press the **Output Button**, the unit will beep three times to indicate the error has been cleared. Press the **Output Button** again to turn on the output current.
- The sensor error condition is triggered by a sensor signal that is either too high or too low a voltage. The table below indicates where each sensor will trigger a sensor error.

SENSOR	Low Sensor Error Condition	High Sensor Error Condition
Thermistor	$\leq 0.01 \text{ V}$	$\geq 4.99 \text{ V}$
RTD	$\leq 0.01 \text{ V}$	$\geq 4.99 \text{ V}$
AD590	$\leq 0.01 \text{ V}$	$\geq 4.99 \text{ V}$
LM335	$\leq 0.01 \text{ V}$	$\geq 4.99 \text{ V}$
LM35	$\leq -4.99 \text{ V}$	$\geq 4.99 \text{ V}$

*Sensor Error LED flashes when sensor is shorted or open. One long beep sounds if error has not been corrected after pressing the **Output Button**.*



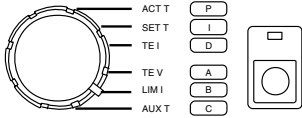

Default Limit Currents

Positive LIM I	= 1.00 Amp
	[LIM I POSITIVE]
Negative LIM I	= -1.00 Amp
	[LIM I NEGATIVE]

Setting Limit Currents

To protect the thermoelectric or resistive heater, positive and negative limit currents can be set below the damage threshold.

Display Limit Currents

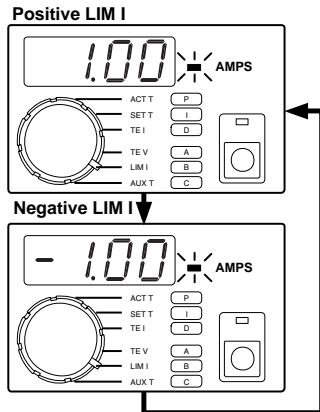

- Rotate the **Display Select Switch** to LIM I (**Shift Button OFF**). Current (in Amps) will be displayed. The positive limit will alternate with the negative limit. Rotating the **Digi-Pot Adjust Knob** clockwise makes the **Positive LIM I** more positive. Rotating the **Digi-Pot Adjust Knob** counter-clockwise makes the **Negative LIM I** more negative.
- To operate a Resistive Heater, set the **Positive Limit** to 0.00 Amps.
- The limit settings will not be updated until the Digi-Pot stops moving.
- When the output is current limited, **TE I** will be within ± 50 mA of the limit setting.
- **LIM I** settings are saved in non-volatile memory.
- When the setpoint and actual temperature are different, the LFI-3751 drives current to the thermoelectric or resistive heater until the load approaches the setpoint temperature. Sometimes the output current is driven up to the limit current settings (indicated by the **LIM I LED** flashing). A lower Limit Current will increase the settling time since less power is delivered to the thermoelectric (or resistive heater).
- The **LIM I LED** in the Status Section flashes when the maximum current (positive or negative) is being sourced to the thermoelectric or resistive heater.
- *RS-232 Command:* [LIM I POSITIVE], [LIM I NEGATIVE]

LIM I LED flashes when Positive or Negative Limit is reached



Display Resolution:

Positive LIM I	0.00 to +5.00 Amps
Negative LIM I	-5.00 to 0.00 Amps

Default Temperature Limits

High Temp Limit = 35.0°C	[T LIM HIGH]
Low Temp Limit = 10.0°C	[T LIM LOW]

Setting Temperature Limits

If the thermoelectric or resistive heater drives the load temperature beyond the temperature limits, the output will shut off and the **T LIMIT LED** will flash.

Display Temperature Limits

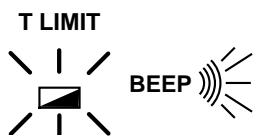
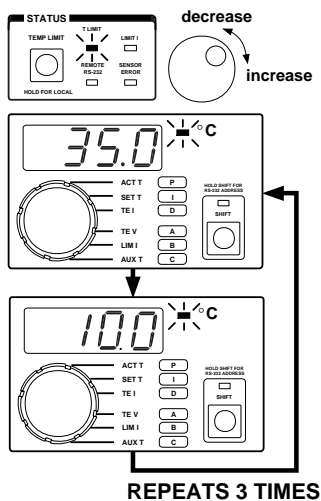

T LIMIT LED flashes when load temperature exceeds either High or Low Limit Temperature. One long beep sounds if error has not been corrected after pressing the **Output Button**.

- Press and release the **TEMP LIMIT Button**. The high and low limits will alternate on the display three times before reverting to the **Display Select Switch** selection.
- Rotate the **Digi-Pot Adjust Knob** to change the value displayed.
- The LFI-3751 uses the lowest number as the Low Temperature LIMIT and the highest number as the High Temperature LIMIT.
- The temperature limits will not be updated until the Digi-Pot stops moving.
- The **T LIMIT LED** in the Status Section lights solid red to indicate the limits are displayed and can be adjusted.
- The Temperature Limits are disabled when thermistors or RTDs are configured to display resistance rather than temperature.
- **High Temp Limit** and **Low Temp Limit** settings are saved in non-volatile memory.
- If you push and release the **TEMP LIMIT Button** or rotate the **Display Select Switch** while displaying the temperature limits, the display will revert to the prior **Display Select Switch** selection.
- If the **T LIMIT LED** flashes and the unit beeps, the load temperature has exceeded one of the limits. The output is forced off. Press the **Output Button** to clear the error. If cleared, the unit beeps three times. Press the **Output Button** again to re-enable output current. If the error persists, the unit will sound a long beep. Once the error is corrected, you can press the **Output Button** to re-enable output current.
- **RS-232 Command:** [T LIM HIGH], [T LIM LOW]



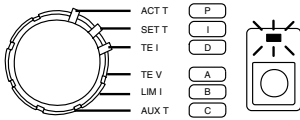

Default P, I, & D Constants

P	= 30	[P]
I	= 1 second	[I]
D	= 0 (OFF)	[D]

Manually Setting the P, I, and D Constants

Selecting optimum PID control parameters that minimize overshoot and maximize stability is even easier now when using the LFI-3751 with Autotune PID. Refer to Autotune PID operation on page 23 for a detailed description of the Autotune feature. The LFI-3751 can be configured to operate as a **P**, **PI**, **PD**, or **PID** temperature controller.

The following sections discuss how to manually adjust the **P**, **I**, and **D** constants.

- For most small loads, set the Proportional Gain to 30, the Integral Time Constant to 1 second, and Differentiator Time Constant to OFF (0).
- The **P**, **I**, and **D** settings are saved in non-volatile memory.
- When first controlling a load, adjust only the **P** term while leaving the **I** term at 1 second and the **D** term OFF. If the load will not stabilize for any **P** term, then increase the **I** term to 2 seconds. Again, adjust the **P** term to optimize the system. Repeat these steps until the load temperature stabilizes around the setpoint temperature. Use the **D** term to reduce overshoot and to damp the system.

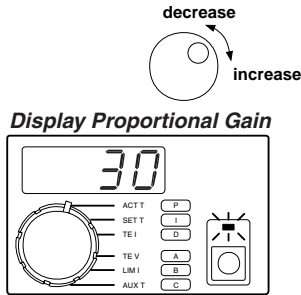

1. Adjusting the P Term

- Rotate the **Display Select Switch** to **P (Shift Button ON)**.
- Rotate the **Digi-Pot Adjust Knob** to change the displayed value.
- The Proportional Gain range is AutS, Autd, and 0 to 100.
- **RS-232 Command: [P]**
- Increasing the proportional gain will improve overall temperature stability. Since most thermal systems are “gain limited”, too high a proportional gain can cause thermal cycling or instability in the instrument’s control loop. If you notice the temperature of your load cycling around the setpoint temperature, then reduce the proportional gain.

Proportional Gain Range	
Auto Setpoint	AutS
Auto Disturbance	Autd
OFF	0.0
ON	0.1 to 100

Display Integral Time Constant

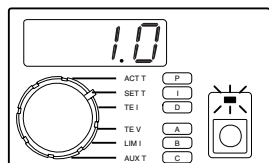

2. Adjusting the I Term

- Rotate the **Display Select Switch** to **I (Shift Button ON)**.
- Rotate the **Digi-Pot Adjust Knob** to change the displayed value.
- **RS-232 Command: [I]**
- Increasing the integrator time constant will improve the instrument's control loop stability (especially with large thermal loads). Increasing the integrator too much produces a sluggish response and long settling times. If you notice the temperature of your load *slowly* approaching the setpoint temperature, then reduce the integrator time constant. Reducing the integrator too much can cause thermal cycling.

Integral Time Constant Range

OFF	0.0
ON	0.4 to 10 seconds

Display Differentiator Time Constant

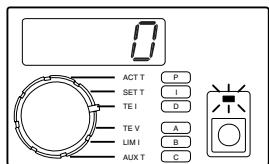

3. Adjusting the D Term

- Rotate the **Display Select Switch** to **D (Shift Button ON)**.
- Rotate the **Digi-Pot Adjust Knob** to change the displayed value.
- **RS-232 Command: [D]**
- Increasing the differentiator time constant also improves the instrument's control loop stability. The differentiator term is typically only useful or necessary for large, hard to control thermal loads. The differentiator term can amplify electrical noise from the sensor. If you notice the temperature of your load *quickly* cycling then reduce the differentiator time constant.

Differentiator Time Constant Range

OFF	0.0
ON	1 to 100 seconds



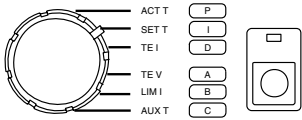

Setting Operating Temperature or Resistance

Default Setpoints

SET T = 25°C	[SET T]
SET R = 10 kΩ	[SET R]

Display Setpoint Temperature or Resistance

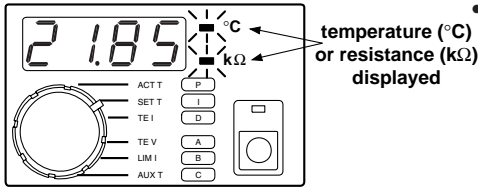
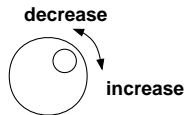

- Rotate the **Display Select Switch** to **SET T (Shift Button OFF)**. Temperature (or resistance) will be displayed.
- To adjust the setpoint, rotate the **Digi-Pot Adjust Knob**. While the knob is rotating, the display will change, but the instrument will not control to the new setpoint until the knob stops moving.
- The decimal point will move to display maximum resolution.
- **SET T** or **SET R** is saved in non-volatile memory.
- **RS-232 Command:** [SET T], [SET R]

Display Resolution:

All Sensors	Temperature	-199.9 to -20.0°C
		-19.99 to 99.99°C
		100.0 to 199.9°C
Thermistor & RTD (in Resistance Mode)	Resistance	0 to 9.999 kΩ
		10.00 to 99.99 kΩ
		100.0 to 499.9 kΩ

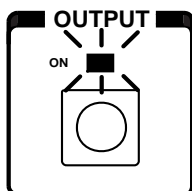
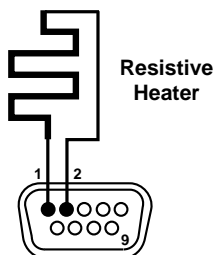
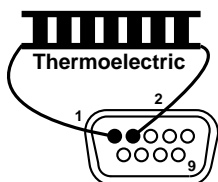

Enabling Output Current

1. Wiring the Output Connector

- Wire the thermoelectric or resistive heater to the **Output Connector** on the rear panel with at least 20 gauge wire. Shielded cables are available (Wavelength part number CAT-220). Do not exceed 1 meter cable length.
- Select your sensor and refer to the appropriate section on Controlling Temperature with that sensor.

2. Adjusting Current and Temperature Limits

- Do not enable current until all the Current Limits, Temperature Limits, and Setpoint are adjusted for your application. See page 56 for Current Limits, 57 for Temperature Limits, and 60 for Setpoint.

3. Enabling Output Current

- Press the **Output Button** to enable current flow through the thermoelectric (or resistive heater). The **Output LED** will light solid green.
- Expect the actual temperature to change in the direction of the setpoint and then stabilize.
- *RS-232 Command:* [RUN / STOP]

4. Disabling Output Current

- Press the **Output Button** to disable current flow through the thermoelectric (or resistive heater). The **Output LED** turns OFF.
- *RS-232 Command:* [RUN / STOP]

5. Clearing Error Conditions

- If the Temperature Limits are exceeded or a Sensor Error occurs, the **T LIMIT LED** or **SENSOR LED** will flash red and the output will turn off. Once the error condition is corrected, press the **Output Button** to clear the error. If successfully cleared, you will hear three beeps. Press the **Output Button** again to re-enable the output current. If the error condition was not corrected, you'll hear one long beep. Pressing the **Output Button** then will produce the long beep until you clear the error. Once the error is cleared, pressing the **Output Button** will enable current.



Measuring Thermoelectric Current and Voltage

Measuring Thermoelectric Current

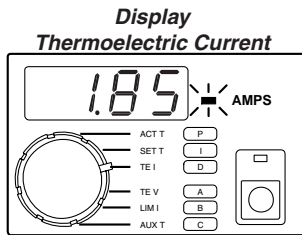

- Rotate the *Display Select Switch* to **TE I (Shift Button OFF)**.
- Current (in Amps) will be displayed with 10 mA resolution.
- The output current is limited by the positive and negative limit currents to -5.00 to +5.00 Amps.
- When the output is disabled, **TE I** will display a small current of up to ± 0.08 Amps. This small current is being supplied to the output. Do not remove the output connector until AC power to the unit is removed.
- *RS-232 Command:* **[TE I]**

Measuring Thermoelectric Voltage

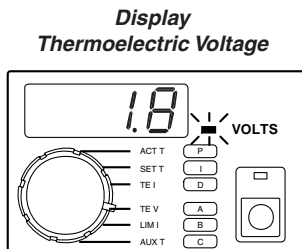

- Rotate the *Display Select Switch* to **TE V (Shift Button OFF)**.
- Voltage (in Volts) will be displayed with 0.1 V resolution.
- The measured voltage across pins 1 & 2 can range from -15.00 to +15.00 V.
- The measurement display assumes using the Wavelength cable (part number CAT-220) which uses one meter of 20 AWG wire.
- With a load, up to ± 0.2 V will be displayed when the output is disabled. Without a load, approximately ± 11 V will be displayed.
- *RS-232 Command:* **[TE V]**

Measuring Auxiliary Thermistor Temperature

This sensor input is available to monitor the temperature of an auxiliary zone (e.g. heatsink or ambient). It is calibrated to the TCS-610 10 kΩ thermistor and uses a 100 μA bias current. The temperature range of this sensor is -8°C to +150°C. Only temperature can be displayed.

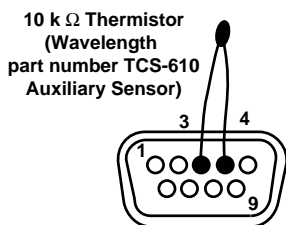

1. Wiring the Output Connector

Wire the thermistor to the output connector on the rear panel.

2. Displaying Auxiliary Temperature

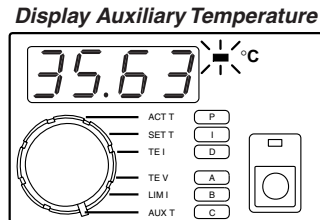

- Rotate the **Display Select Switch** to **AUX T (Shift Button OFF)** to display the auxiliary sensor temperature.
- The decimal point position changes automatically to display maximum resolution.
- If not installed, four dashes will be displayed “----”.
- *RS-232 Command:* [AUX T]

Display Resolution:

-199.9	to	-20.0°C
-19.99	to	99.99°C
100.0	to	199.9°C



TCS-610 Temperature vs. Resistance Chart

Temperature, °C	Resistance, kΩ	Temperature, °C	Resistance, kΩ
-8	49.67	32	7.402
-7	47.08	33	7.098
-6	44.64	34	6.808
-5	42.34	35	6.531
-4	40.17	36	6.267
-3	38.12	37	6.015
-2	36.20	38	5.774
-1	34.38	39	5.545
0	32.66	40	5.326
1	31.04	41	5.116
2	29.51	42	4.916
3	28.06	43	4.725
4	26.69	44	4.543
5	25.40	45	4.368
6	24.18	46	4.201
7	23.02	47	4.041
8	21.92	48	3.888
9	20.89	49	3.742
10	19.90	50	3.602
11	18.97	51	3.468
12	18.09	52	3.340
13	17.26	53	3.217
14	16.47	54	3.099
15	15.71	55	2.987
16	15.00	56	2.878
17	14.32	57	2.775
18	13.68	58	2.675
19	13.07	59	2.580
20	12.49	60	2.489
21	11.94	61	2.401
22	11.42	62	2.317
23	10.92	63	2.236
24	10.45	64	2.158
25	10.00	65	2.084
26	9.572	66	2.012
27	9.165	67	1.944
28	8.777	68	1.878
29	8.408	69	1.814
30	8.056	70	1.753
31	7.721	71	1.695



Chapter 2 - Front Panel Operation
Measuring Auxiliary Thermistor Temperature

Temperature, °C	Resistance, kΩ	Temperature, °C	Resistance, kΩ
72	1.638	112	0.4835
73	1.584	113	0.4704
74	1.532	114	0.4577
75	1.482	115	0.4454
76	1.433	116	0.4335
77	1.387	117	0.4219
78	1.342	118	0.4108
79	1.299	119	0.3999
80	1.258	120	0.3894
81	1.218	121	0.3793
82	1.179	122	0.3694
83	1.142	123	0.3598
84	1.106	124	0.3506
85	1.072	125	0.3416
86	1.039	126	0.3329
87	1.007	127	0.3244
88	0.9759	128	0.3162
89	0.9461	129	0.3083
90	0.9174	130	0.3005
91	0.8897	131	0.2930
92	0.8630	132	0.2858
93	0.8372	133	0.2787
94	0.8123	134	0.2718
95	0.7882	135	0.2652
96	0.7650	136	0.2587
97	0.7426	137	0.2524
98	0.7209	138	0.2464
99	0.7000	139	0.2404
100	0.6798	140	0.2347
101	0.6602	141	0.2291
102	0.6413	142	0.2236
103	0.6231	143	0.2184
104	0.6054	144	0.2132
105	0.5884	145	0.2082
106	0.5719	146	0.2034
107	0.5559	147	0.1987
108	0.5404	148	0.1941
109	0.5255	149	0.1896
110	0.5110	150	0.1853
111	0.4970		



Setting the RS-232 Address

Default Address

RS-232 address: 01

Display RS-232 Address

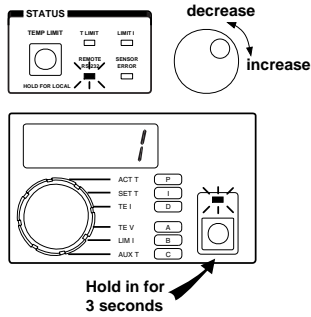

- Press and hold the **Shift Button**. After three seconds, the RS-232 address will be displayed.
- The **REMOTE RS-232 LED** will light solid to indicate the address is displayed and can be adjusted.
- Continue to hold the **Shift Button** and rotate the **Digi-Pot Adjust Knob** to change the value from 1 to 99.
- Release the **Shift Button** to save the displayed RS-232 address.
- The RS-232 address can only be changed via the front panel.

Release the **SHIFT Button** to save the displayed RS-232 address.

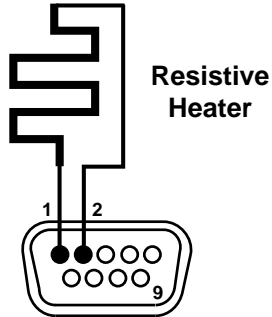

Operating with Resistive Heaters

2

Resistive Heater operation is similar to operation with thermoelectrics except only heating current is delivered to a resistive heater.

- The LFI-3751 can be configured to deliver only heating current by adjusting the **Positive Current Limit** to 0.00 Amps.
- Since the LFI-3751 has a limited output voltage of 8 Volts at 5 Amps, select a low value resistive heater to use the maximum power from the LFI-3751.



This page intentionally left blank.



3

3

Chapter 3: Rear Panel Operation

Rear Panel Operation

This chapter details the sections of the rear panel and provides pinouts for all connectors.



Connector Pinouts

1. Output Connector (9 pin male D-sub plug)

Output Connector
 9 pin male D-sub plug

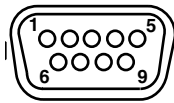

1	TEC +
2	TEC -
3	Aux Sensor +
4	*Sensor -
5	Main Sensor +
6	AD590 Voltage
7	*Fan -
8	*Fan+ (+12 V)
9	*-12 V

* Thermally Fused to 100 mA

- The thermoelectric or resistive heater is wired between pins 1 & 2. Regardless of your sensor type, always attach the positive lead of the thermoelectric to pin 1.
- The Auxiliary sensor (10 kΩ thermistor, Wavelength part number TCS-610) connects between pins 3 & 4.
- A thermally fused fan output is available to drive a 100 mA fan. Wire the fan between pins 8 & 7.
- Pin 8 is also used to connect an LM35.
- For thermistors, RTDs, or the LM335, connect the sensor between pins 5 & 4. For an AD590, connect the positive terminal to pin 6 and the negative to pin 5. For an LM35, an external 240 kΩ resistor is required. See Chapter 2 for individual sections that detail the sensor usage.

3

Example Thermistor Wiring

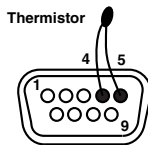

Example RTD Wiring

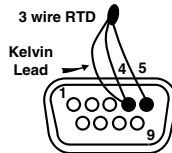
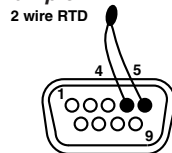

Example AD590 Wiring

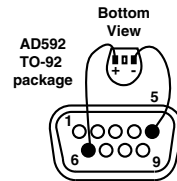
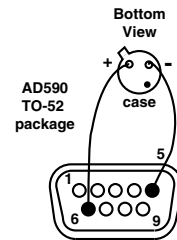

Example LM335 Wiring

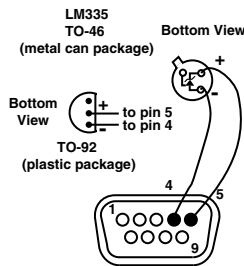

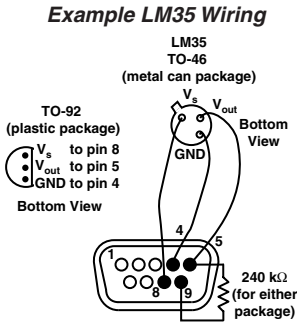

RS-232 Output
 (25 pin male D-sub plug)

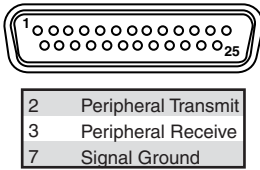

RS-232 Input
 (25 pin female D-sub receptacle)

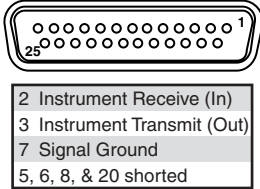

2. RS-232 Connectors

These connectors meet the RS-232C standard for wiring. See Chapter 4 for detailed RS-232 commands. Some computers may require a null modem for proper operation. Check your computer's RS-232 port for proper wiring before connecting to the instrument.

RS-232 Output

The RS-232 output connects to another Wavelength Electronics instrument with addressable RS-232 interface. The **RS-232 OUTPUT** always connects to the other instrument's **RS-232 INPUT** connector. Up to 99 instruments can be daisy chained together and controlled from one RS-232 port on a computer.

RS-232 Input

The RS-232 input can be connected to any RS-232 port on a computer. The proper configuration of the computer's RS-232 port is 8, N, 1 (8 bits, no parity, 1 stop bit).

3. Controlling Multiple Instruments via RS-232

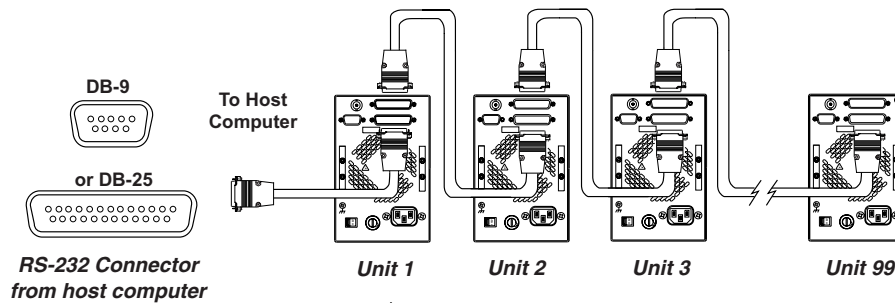

BNC Connector [Used with Analog Version only]

Analog Input BNC



Analog Input BNC

Input a 0 to ± 10 V analog signal to adjust the setpoint remotely. The sum of the front panel **SET T** setting and analog input determine the control temperature. If not using the analog input, install the 50 Ω BNC terminator provided with the unit to minimize electrical noise and protect against electro-static discharge. The transfer functions change according to the sensor type and bias current.

3

Analog Input Transfer Functions

Thermistors & RTDs (10 μ A or 100 μ A)	10 k Ω / V
Thermistors & RTDs (1 mA or 10 mA)	100 Ω / V
LM335/35, AD590, Thermocouples	10 $^{\circ}$ C / V

- Example: With a thermistor biased with 100 μ A, if **SET R** is 12 k Ω , if you input +0.2 V at the **Analog Input BNC**, the setpoint becomes:
 $12 \text{ k}\Omega + (0.2 \text{ V}) (10 \text{ k}\Omega / \text{V}) = 14 \text{ k}\Omega$
- *RS-232 Command:* [**MOD Gain Configuration**]



AC Power

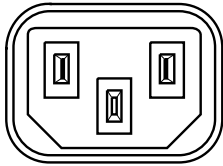

LINE:
115/230 VAC, 50/60 Hz, 160 VA

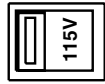

SELECT:

1. AC Power Entry Module

The **AC Power Entry Module** on the rear panel is designed to accept input voltages from 98 to 133 and 196 to 265 VAC. Ensure that the power source you plug the temperature controller into is properly grounded.

2. AC Voltage Select Switch

The **Voltage Select Switch** configures the instrument for 115 or 230 VAC operation. Before connecting power to your instrument, check the **Voltage Select Switch** for proper AC voltage in your country. Only use the power cord supplied with your instrument.

Do not change the setting of this switch while power is supplied to the instrument. See the table below for the proper AC Voltage selection.

AC Voltage Available	Voltage Select
98 -133 VAC	115 V
196 -265 VAC	230 V

FUSE (250V):
2000 maT @ 115V
1000 maT @ 230V
(5x20mm SLO BLO)



3. AC Fuse

For 115 VAC operation, install a 2000 maT fuse 5 x 20 mm SLO BLO fuse.

For 230 VAC operation, install a 1000 maT fuse 5 x 20 mm SLO BLO fuse.



4. Earth Ground Connection

If your AC power system does not bring earth ground through the **AC Power Entry Module**, then connect earth ground via a 16 AWG wire to this screw terminal.

Chapter 4: Remote Interface Reference



Remote Interface Reference

This chapter details the RS-232 hardware, command and response packet structure, and how to use each command. Command codes and error codes are also listed.

All example command strings assume the instrument's RS-232 address is 01.



RS-232 Interface Configuration

You connect an LFI-3751 to the RS-232 interface using the 25-pin D-sub serial connector (DB-25) on the rear panel (**RS-232 Input Connector**). You can add up to 98 more LFI-3751s by connecting the **RS-232 Output Connector** on the rear panel of the first unit to the **RS-232 Input Connector** on the rear panel of the second and so on (daisy chain configuration). The temperature controller is **not** configured as a DTE (Data Terminal Equipment) device. If your serial port is configured as a DTE device, you do not need a null modem to communicate with the LFI-3751. The LFI-3751 uses software XON/XOFF flow control.

1. RS-232 Configuration Overview

- Communication conforms to the RS-232C interface specifications.
- Up to 99 temperature controllers can be connected to each RS-232 port on the host computer.
- Cable length should not exceed 15 meters between computer and LFI-3751 or between two LFI-3751s.
- Use shielded, twisted pair cables (AWG 28 minimum).
- The communications specifications of the LFI-3751 are fixed. Set the host computer to match the specifications listed below.

**RS-232
Communication
Settings**

Parameter	Setting
Baud Rate	19.2 kbps
Bit Length	8 Bit
Parity	No Parity
Stop Bit	1 Stop Bit



1. Connections to a Computer

- Pins 5, 6, 8, and 20 on the LFI-3751 **RS-232 Input Connector** are shorted at the connector to ensure that the computer serial port is properly configured to transmit and receive data. Pin 4 on the 9 pin D-Sub male plug (*Data Terminal Ready Out*) provides the appropriate handshaking to the computer's *Data Carrier Detect In* (pin 1), *Data Set Ready In* (pin 6), and *Clear to Send In* (pin 8).
- Pins 5, 6, 8, and 20 on the LFI-3751 **RS-232 Input Connector** do not connect to any internal circuitry.

DB-9 Serial Connection

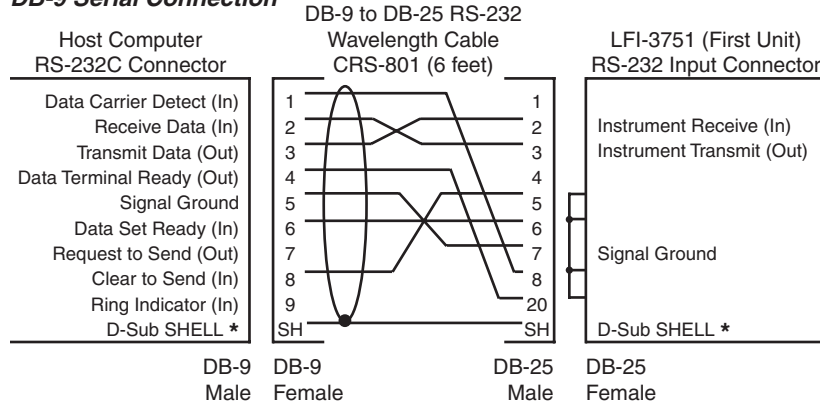

* D-Sub Shell on LFI-3751 is connected to chassis. Always properly earth ground the LFI-3751 chassis through your AC power system.

DB-25 Serial Connection

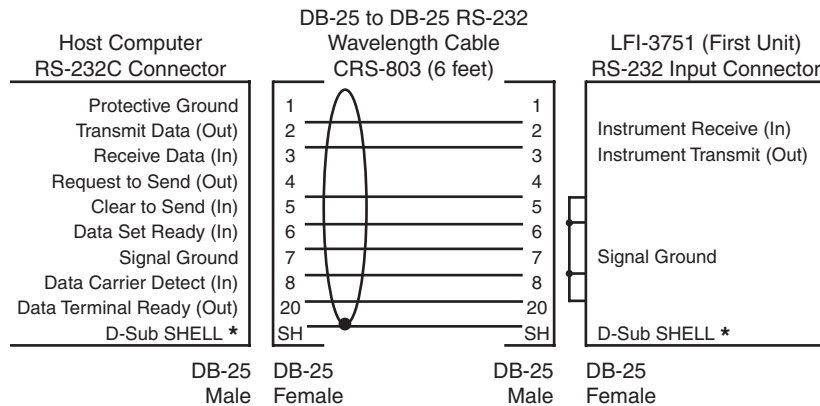

* D-Sub Shell on LFI-3751 is connected to chassis. Always properly earth ground the LFI-3751 chassis through your AC power system.

2. Connections between instruments

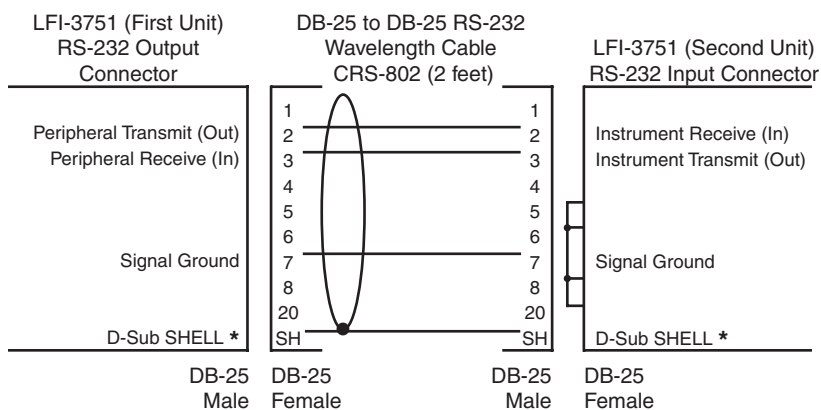

* D-Sub Shell on LFI-3751 is connected to chassis. Always properly earth ground the LFI-3751 chassis through your AC power system.

4

3. Controlling Multiple Instruments via RS-232

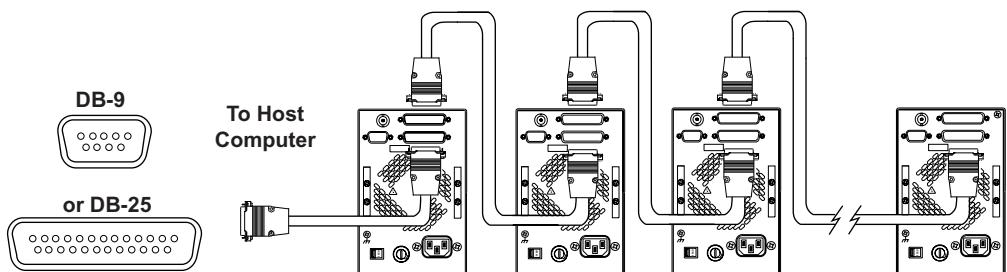

4. RS-232 Connector Pinouts

RS-232 Input
 (25 pin female D-sub receptacle)

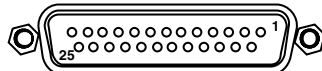

- 2 Instrument Receive (In)
- 3 Instrument Transmit (Out)
- 7 Signal Ground
- 5, 6, 8, & 20 shorted

RS-232 Output
 (25 pin male D-sub plug)

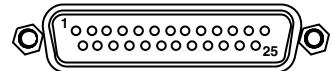

- 2 Peripheral Transmit (Out)
- 3 Peripheral Receive (In)
- 7 Signal Ground



RS-232 Command and Response Packet Formats

- The host computer sends a *Command Packet* to the instrument and the temperature controller returns a *Response Packet* to the host computer. A *Response Packet* always returns after each *Command Packet* is sent. The **[HALT PROCESSOR]** command is the only exception. The processor is immediately halted and does not return a *Response Packet*.
- All characters in the *Command and Response Packets* are ASCII. The character fields are decimal ['0' to '9'] except for the Frame Check Sum (FCS) which is represented in HEX ['0' to '9' or 'A' to 'F'].
- The characters within the packets follow a rigid structure. The instrument's parser expects 17 characters in a *Command Packet*. Extra *Command Packet* characters will be ignored until a new start character is received. A *Response Packet* always contains 21 characters.
- READ commands (Command Type 1) do not use the data field. The data field must still contain a number between -999.999 and +999.999.
- There are no restrictions on how fast the host computer sends characters to the instrument. The packets can be sent at one character per second or using the full 19200 baud capacity. If the host computer can't buffer the instrument's *Response Packets* at full speed, configure the host computer's RS-232 port for XON/XOFF flow control.
- When a value is written to the instrument in a *Command Packet*, the corresponding *Response Packet* will return the instrument's interpretation of the value. For example, if the data field for the **[SET T]** *Command Packet* is +120.263, then the *Response Packet* will return +120.300 in its data field.
- The instrument's measurements are updated about every 600 milliseconds with an additional delay of about 750 milliseconds every ten minutes when the unit automatically zeros the instrument's measurement A/D. The 19.2 k BAUD rate allows Measurement Reads about every 19.8 milliseconds. The instrument returns the most recent value immediately so as not to tie up the interface in a multi-packet, multi-instrument environment. If a new measurement is required for each *Command Packet*, program in a 800 millisecond delay between *Command Packets*.
- No *Response Packet* is returned from any unit unless it at least receives a valid Start Character, a matching Unit Type and Unit Number.

Command Packet

Command Start	Unit Type	Unit #	Command Type	Command Code	Data	FCS
!	1	X X	X	X X	± X X X . X X X	X X
						7 6 5 4 3 2 1 0
						Data Field Characters

Response Packet

Response Start	Unit Type	Unit #	Command Type	Command Code	End Code	Data	FCS	CR LF
@	1	X X	X	X X	X X	± X X X . X X X	X X	CR LF
						7 6 5 4 3 2 1 0		
						Data Field Characters		

Command Start	!	Signifies the start of a <i>Command Packet</i> .
Response Start	@	Signifies the start of a <i>Response Packet</i> .
Unit Type [Decimal]	1 - 2	1 = Temperature Controller 2 = Laser Diode Driver
Unit # [Decimal]	01 - 99	RS-232 address of the unit as set on the front panel of the unit (00 is reserved)
Command Type [Decimal]	1 - 2	1 = Read data 2 = Write data
Command Code [Decimal]	00 - 99	Specifies the type of command to initiate. See “Command Code Listing” for detail.
End Code [Decimal]	00 - 99	Response indicating action success or failure. See “End Code Listing” for detail.
Data [Decimal]	±XXX.XXX	Data must match this format exactly. A sign character is followed by three digits, a decimal point, and three digits. Data is decimal and between -999.999 and +999.999.
FCS [HEX]	00 - FF	Number used to check the data received and sent. See “Calculating FCS” for detail.
CR LF		Carriage Return and Line Feed included in <i>Response Packet</i> .

4



Standard Command Code Listing

Command	Command Type	Command Code	Description and Data Field Range
ACT T	1	01	Actual Temperature Measurement ^①
ACT R	1	02	Actual Sensor Resistance Measurement ^①
SET T	1 or 2	03	Temperature Setpoint: -199.900 to +199.900°C
SET R	1 or 2	04	Resistance Setpoint: +000.000 to +499.900 kΩ
TE I	1	05	Thermoelectric Current Measurement ^①
TE V	1	06	Thermoelectric Voltage Measurement
LIM I POSITIVE	1 or 2	07	Positive Current Limit: +000.000 to +005.000 Amps
LIM I NEGATIVE	1 or 2	08	Negative Current Limit: -005.000 to +000.000 Amps
AUX T	1	09	Auxiliary Sensor Temperature Measurement
P	1 or 2	10	Proportional Gain: -002.000 Setpoint Response Autotune -001.000 Disturbance Rejection Autotune +000.000 to +100.000 Amps / Volt
I	1 or 2	11	Integral Time Constant: +000.000 = OFF or +000.400 to +010.000 sec
D	1 or 2	12	Differentiator Time Constant: +000.000 = OFF or +001.000 to +100.000 sec
A1	1 or 2	21	Sensor Configuration Term: -199.900 to +199.900°C
A2	1 or 2	22	Sensor Configuration Term: +000.000 to +499.900 kΩ
B1	1 or 2	23	Sensor Configuration Term: Range is a function of sensor. See below.
B2	1 or 2	24	Sensor Configuration Term: Range is a function of sensor. See below.
C1	1 or 2	25	Sensor Configuration Term: Range is a function of sensor. See below.
C2	1 or 2	26	Sensor Configuration Term: Range is a function of sensor. See below.
T LIM HIGH	1 or 2	31	High Temperature Limit: -199.900 to +199.900°C
T LIM LOW	1 or 2	32	Low Temperature Limit: -199.900 to +199.900°C

^① These measurement values return full floating point precision.

Sensor Type	Range of [B1]	Range of [B2]	Range of [C1]	Range of [C2]
Thermistor	-199.900 to +199.900°C	+000.000 to +499.900 kΩ	-199.900 to +199.900°C	+000.000 to +499.900 kΩ
RTD	-199.900 to +199.900°C	+000.000 to +499.900 kΩ	-199.900 to +199.900°C	+000.000 to +499.900 kΩ
AD590	+000.100 to +009.999 μA / K	-	-009.990 to +009.990 μA	-
LM335	+001.000 to +020.000 mV / K	-	-009.990 to +009.990 mV	-

Chapter 4 - Remote Interface Reference
Standard Command Code Listing

Command	Command Type	Command Code	Description and Data Field Range
Alarm Status	1	35	Char 7 = Sign Char [+ always] Char 6 = Sensor Open Error [0 = OK, 1 = Error] Char 5 = Sensor Short Error [0 = OK, 1 = Error] Char 4 = Low Temperature Limit [0 = OK, 1 = Error] Char 3 = Decimal Point Char 2 = High Temperature Limit [0 = OK, 1 = Error] Char 1 = Current Limit [0 = OK, 1 = Error] Char 0 = Output Status [0 = Output Off, 1 = Output On]
Sensor Bias Configuration To Set Sensor Bias, enter '+' in Char 7 with settings in Char 6 - 0. To Return to Auto Sensor Bias Current, enter '-' in Char 7 or turn off power.	1 or 2	41	Char 7 = Sign Char [+ = manual, - = automatic] Char 6 = NTC / PTC Sensor [0 = NTC, 1 = PTC] Char 5 = AD590 [0 = OFF, 1 = use 10 kΩ resistor for feedback] Char 4 = 10 mA [0 = OFF, 1 = use 10 mA bias current] Char 3 = Decimal Point Char 2 = 1 mA [0 = OFF, 1 = use 1 mA bias current] Char 1 = 100 μA [0 = OFF, 1 = use 100 μA bias current] Char 0 = 10 μA [0 = OFF, 1 = use 10 μA bias current]
MOD Gain Configuration To Set Analog Input Gain (BNC on rear panel), enter '+' in Char 7 with settings in Char 2 - 0. To Return to Auto Analog Input Gain, enter '-' in Char 7 or turn off power.	1 or 2	42	Char 7 = Sign Char [+ = manual, - = automatic] Char 6 = Not Used Char 5 = Not Used Char 4 = Not Used Char 3 = Decimal Point Char 2 = Mod Gain 3 (100 : 1) [0 = OFF, 1 = ON] Char 1 = Mod Gain 2 (10 : 1) [0 = OFF, 1 = ON] Char 0 = Mod Gain 1 (1 : 1) [0 = OFF, 1 = ON]
RUN/STOP	1 or 2	51	To Enable Output or Initiate Autotune: Write data is +XXX.XX1 To Disable Output or Abort Autotune: Write data is +XXX.XX0 Char 5 = Autotune Error Codes 1 = Zero Value Current Limit Error 2 = Current Limit Cannot reach SET T 3 = Non-uniform TE I step measured 4 = Rate Sign Change Char 4 = Autotune Status [0 = Normal, 1 = Autotune] Char 3 = Decimal Point Char 2 = Temp Limit or Error Limit Status [1 = requires clearing] Char 1 = Integrator Status [0 = OFF, 1 = ON] Char 0 = Output Status [0 = OFF, 1 = ON]



Chapter 4 - Remote Interface Reference
Standard Command Code Listing

Command	Command Type	Command Code	Description and Data Field Range
HALT PROCESSOR	2	52	Turns all lamps off, disables interrupts, and shuts off all timers, clocks, and watchdog then freezes the CPU. Remove power to reset unit.
LOCAL	2	53	Restore to local operation. Returns <i>Response Packet</i> as last act.
PASSWORD ②	1 or 2	54	Factory set password to access calibration and diagnostics mode. Read the current state of password flag in Char 0 0 = PASSWORD not issued; 1 = PASSWORD properly issued
SERIAL NUMBER ②	1 or 2	55	Enter or read unit serial number - PASSWORD required to enter serial number
FIRMWARE VERSION	1	56	Read firmware version.
MODEL NO. ②	1	57	Read Model Number.

② These *Command* and *Response Packets* violate the ±XXX.XXX data format. The data field is used for eight ASCII characters: 'XXXXXXXX'. No other commands violate the standard data format.

Calibration Command Code Listing

- All WRITE *Command Packets* are PASSWORD protected.

Command	Command Type	Command Code	Description & Data Field Range
10 μ A BIAS CAL	1 or 2	61	Enter actual 10 μ A sensor bias current in μ A
100 μ A BIAS CAL	1 or 2	62	Enter actual 100 μ A sensor bias current μ A
1 mA BIAS CAL	1 or 2	63	Enter actual 1 mA sensor bias current in mA
10 mA BIAS CAL	1 or 2	64	Enter actual 10 mA sensor bias current in mA
AD590 10 k Ω CAL	1 or 2	65	Enter actual 10 k Ω resistance for sensing AD590 current in k Ω
RAW ACT T VOLT	1	71	Measure uncalibrated ACT T voltage in Volts
RAW TE I VOLT	1	72	Measure uncalibrated TE I voltage in Volts
RAW TE V VOLT	1	73	Measure uncalibrated TE V voltage in Volts
ACT T SLOPE CAL	1 or 2	74	Calibrate ACT T slope
ACT T OFFSET CAL	1 or 2	75	Calibrate ACT T offset
TE I SLOPE CAL	1 or 2	76	Calibrate TE I slope
TE I OFFSET CAL	1 or 2	77	Calibrate TE I offset
TE V SLOPE CAL	1 or 2	78	Calibrate TE V slope
TE V OFFSET CAL	1 or 2	79	Calibrate TE V offset
POS SET T SLOPE CAL	1 or 2	80	Calibrate positive SET T slope
POS SET T OFFSET CAL	1 or 2	81	Calibrate positive SET T offset
NEG SET T SLOPE CAL	1 or 2	82	Calibrate negative SET T slope
NET SET T OFFSET CAL	1 or 2	83	Calibrate negative SET T offset
TE POS LIM I SLOPE CAL	1 or 2	84	Calibrate LIM I POSITIVE slope
TE POS LIM I OFFSET CAL	1 or 2	85	Calibrate LIM I POSITIVE offset
TE NEG LIM I SLOPE CAL	1 or 2	86	Calibrate LIM I NEGATIVE slope
TE NEG LIM I OFFSET CAL	1 or 2	87	Calibrate LIM I NEGATIVE offset
RESTORE FACTORY CALIBRATION DEFAULTS	2	88	Resets the calibration constants to factory defaults



Diagnostic Command Code Listing

Command	Command Type	Command Code	Description and Data Field Range
LAMP CONTROL To check the lamps, enter '+' in Char 7 with settings in Char 6 - 0. To return to Normal Operation, enter '-' in Char 7 or turn off power.	2	91	Turns Front Panel Lamps on and off. Char 7: Sign Char [+ = manual, - = automatic] Char 6: Sequence Lamps [0 = OFF, 1 = Lamp ON] Char 5: All Lamps ON [0 = OFF, 1 = Lamp ON] Char 4: 7 Segment Displays [0 = OFF, 1 = Lamp ON] Char 3: Decimal Point Char 2: Unit of Measure & Shift LEDs [0 = OFF, 1 = Lamp ON] Char 1: Status LEDs [0 = OFF, 1 = Lamp ON] Char 0: Output ON LED [0 = OFF, 1 = Lamp ON]
PUSHBUTTON SWITCH STATUS	1	92	OUTPUT, SHIFT, & TEMP LIMIT Pushbutton Status Char 7 = Sign Char (Not Used); Returns '+' Char 6, 5, 4 = (Not Used); Returns '000' Char 3 = Decimal Point Char 2 = Temp Limit Pushbutton [0 = OFF, 1 = ON] Char 1 = Shift Pushbutton [0 = OFF, 1 = ON] Char 0 = Output Pushbutton [0 = OFF, 1 = ON]
ROTARY SWITCH STATUS	1	93	Rotary Switch Status A '1' indicates position of rotary switch Char 7 = Sign Char (Not Used); Returns '+' Char 6 = AUX T / C Char 5 = LIM I / B Char 4 = TE V / A Char 3 = Decimal Point Char 2 = TE I / D Char 1 = SET T / I Char 0 = ACT T / P
DIGIPOT STATUS <i>When DIGI-POT is not moving, this command clears the DIGI-POT counter. Once the DIGI-POT is moving, this command reads the DIGI-POT counter. The counter will contain the number of interrupts generated since counter was last cleared. DIGI-POT has 32 interrupts per rotation.</i>	1	94	Read Digi-Pot counter Char 7 = Sign Char: '+' = clockwise, '-' = counterclockwise Char 6, 5, 4 = Integer Number of Interrupts since last cleared Char 3 = Decimal Point Char 2 = 0 Char 1 = 0 Char 0 = 0



End Code Listing

End Code	Description
00	Normal Ending - No errors
01	Command Type not supported (Valid values are '1' or '2')
02	Illegal ASCII digit contained in Command Code or FCS field
03	Data field Char 7 must be '+' or '-'
04	Data field Char 3 must be '.'
05	Data field Char 6, 5, 4, 2, 1, or 0 contains an illegal ASCII character (not '0' to '9')
20	Command Type not supported for Command Code (for example, executing an ACT T measurement with '2' = WRITE as Command Type)
21	PASSWORD protected data - no PASSWORD issued prior to command execution
22	Command Code not implemented
23	FCS does not match computed FCS for this <i>Command Packet</i>
24	Parser programming error. Please contact factory.
25	Write command requires '1' or '0' in one of the data characters. Invalid ASCII value found.
26	Query Calculation Error. Instrument unable to calculate requested measurement. Data returned is '+999.999'
27	Sensor Configuration data written while Output is on. Sensor Data unchanged.
81	RS-232 Lamp Control Write Error- Data characters not valid. One test state allowed per write. Ignoring the decimal point, data must translate to a binary value of 0, 1, 2, 4, 8, 16, or 32.



This page intentionally left blank.



Starting RS-232 Communication with the LFI-3751

Once you have connected a computer and at least one LFI-3751, set the unit's RS-232 address from the front panel.

Display RS-232 Address

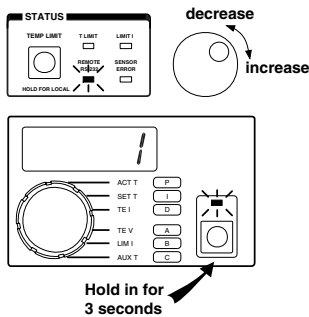

Release the **SHIFT Button** to save the displayed RS-232 address.

1. Set RS-232 address

- Press and hold the **Shift Button**. After three seconds, the RS-232 address will be displayed.
- The **REMOTE RS-232 LED** will light solid to indicate the address is displayed and can be adjusted.
- Continue to hold the **Shift Button** and rotate the **Digi-Pot Adjust Knob** to change the value from 1 to 99.
- Release the **Shift Button** to save the displayed RS-232 address.
- The RS-232 address can only be changed via the front panel.

4

2. Send a Command Packet

Then, simply send a *Command Packet* to that instrument's address.

- The **REMOTE RS-232 LED** will flash to indicate communication is occurring. The LED will light solid if the unit has not reverted to LOCAL mode, and no communication with the host computer is ongoing.

The following sections detail how to operate the LFI-3751 via RS-232 communication.



RS-232
Commands Discussed:

[A1]
[A2]
[B1]
[B2]
[C1]
[C2]

Configuring the Sensor

For complete detail about sensor configuration, see Chapter 2.

1. Characterizing Temperature Response

- Four or six parameters must be set depending on the type of sensor you're using: [A1], [A2], [B1], [B2], [C1], and [C2]. [B2] and [C2] are used for thermistors and RTDs only.
- For example, to configure a thermistor, three (Temperature, Resistance) data pairs are entered to establish how the thermistor resistance changes with temperature. Six *Command Packets* are sent to configure these values. The following packets configure the instrument for a TCS-610 10 kΩ thermistor operating around 25°C. The three configuration data pairs are (10°C, 19.9 kΩ), (25°C, 10 kΩ), and (40°C, 5.326 kΩ).

Write

!101221+010.00024	<i>(Sets [A1])</i>
!101222+019.90027	<i>(Sets [A2])</i>
!101223+025.00020	<i>(Sets [B1])</i>
!101224+010.00021	<i>(Sets [B2])</i>
!101225+040.00025	<i>(Sets [C1])</i>
!101226+005.32620	<i>(Sets [C2])</i>

- The table on the next page details the Command Codes and expected data for all the sensors supported by the LFI-3751.
- To read the current sensor configuration, the Command Type changes from a WRITE (2) to a READ (1):

Read

!101121+000.00026	<i>(Reads [A1])</i>
!101122+000.00025	<i>(Reads [A2])</i>
!101123+000.00024	<i>(Reads [B1])</i>
!101124+000.00023	<i>(Reads [B2])</i>
!101125+000.00022	<i>(Reads [C1])</i>
!101126+000.00021	<i>(Reads [C2])</i>

Chapter 4 - Remote Interface Reference
Configuring the Sensor

Command Codes and Expected Data to Configure Supported Sensors

Sensor Type	RS-232 Command	Command Code	Data Description	Data Range
Thermistor	[A1]	21	Temperature 1	-199.900 to +199.900°C
	[A2]	22	Resistance 1	+000.000 to +499.900 kΩ
	[B1]	23	Temperature 2	-199.900 to +199.900°C
	[B2]	24	Resistance 2	+000.000 to +499.900 kΩ
	[C1]	25	Temperature 3	-199.900 to +199.900°C
	[C2]	26	Resistance 3	+000.000 to +499.900 kΩ
RTD	[A1]	21	Sensor Type	+001.000
	[A2]	22	Sensor Type	+001.000
	[B1]	23	Temperature 1	-199.900 to +199.900°C
	[B2]	24	Resistance 1	+000.000 to +499.900 kΩ
	[C1]	25	Temperature 2	-199.900 to +199.900°C
	[C2]	26	Resistance 2	+000.000 to +499.900 kΩ
AD590	[A1]	21	Sensor Type	+002.000
	[A2]	22	Sensor Type	+002.000
	[B1]	23	Slope	+000.100 to +009.999 μA / K
	[C1]	25	Offset	-009.990 to +009.990 μA
LM335	[A1]	21	Sensor Type	+003.000
	[A2]	22	Sensor Type	+003.000
	[B1]	23	Slope	+001.000 to +020.000 mV / K
	[C1]	25	Offset	-009.990 to +009.990 mV
LM35	[A1]	21	Sensor Type	+004.000
	[A2]	22	Sensor Type	+004.000
	[B1]	23	Slope	+001.000 to +020.000 mV / °C
	[C1]	25	Offset	-009.990 to +009.990 mV

4

- Sensor Data [A1], [A2], [B1], [B2], [C1], or [C2] cannot be changed while the Output is ON.



2. Selecting Automatic or Manual Sensor Bias

RS-232
Commands Discussed:

[Sensor Bias Configuration]

Typical Sensor Settings

Sensor Type	NTC or PTC Sensor	Typical Bias Current or Sense Resistance
Thermistor	NTC	10 μ A or 100 μ A
RTD	PTC	1 mA or 10 mA
AD590	PTC	10 k Ω resistor across output
LM335	PTC	1 mA
LM35	PTC	10 k Ω resistor across output

- The temperature controller automatically adjusts the sensor bias current to optimize the sensor voltage and also allow a wider temperature operating range. You can control the feedback or bias current selection with the **[Sensor Bias Configuration]** Command. This command also controls the loop polarity (NTC or PTC sensor). For example, the following *Command Packet* sets the bias current to 10 μ A.

Write
!101241+000.00122
(Sets Sensor Bias to manual 10 μ A for an NTC sensor)

- This command is helpful for configuring the instrument for use with non-standard temperature sensors.
- The following table details the structure of the characters in the data field.

Char 7 = Sign Char [+ = manual, - = automatic]
Char 6 = NTC / PTC Sensor [0 = Negative Temperature Coefficient Sensor, 1 = Positive Temperature Coefficient Sensor]
Char 5 = AD590 [0 = OFF, 1 = use 10 k Ω resistor for feedback]
Char 4 = 10 mA [0 = OFF, 1 = use 10 mA bias current]
Char 3 = Decimal Point
Char 2 = 1 mA [0 = OFF, 1 = use 1 mA bias current]
Char 1 = 100 μ A [0 = OFF, 1 = use 100 μ A bias current]
Char 0 = 10 μ A [0 = OFF, 1 = use 10 μ A bias current]

Chapter 4 - Remote Interface Reference
Configuring the Sensor

- When writing the **[Sensor Bias Configuration]** command, Character 7 (+ or -) configures the instrument to manual or automatic mode. A '+' puts the sensor configuration under manual control. A '-' lets the instrument automatically configure the sensor. When a '-' is in Character 7, Characters 6 through 0 are ignored when writing.

Character 6 determines the feedback polarity. A thermistor is a Negative Temperature Coefficient Sensor. All others are Positive Temperature Coefficient Sensors.

You can combine settings to integrate a unique sensor. For example, if you need 11 mA bias current, you can set Character 4 and Character 2 to '1' to produce an 11 mA bias current.

- When reading the Sensor Bias Configuration, the Command Type changes from a WRITE (2) to a READ (1):

Read

!101141+000.00020

(Reads [Sensor Bias Configuration])

This helps you determine what sensor configuration the instrument is using.



Measuring Actual Temperature or Resistance

RS-232
Commands Discussed:

[ACT T]
[ACT R]

- To measure actual sensor temperature from an instrument, send the following *Command Packet*.

Read
!101101+000.00024 (Reads [ACT T] in °C)

- To measure actual sensor resistance from an instrument, send the following *Command Packet*.

Read
!101102+000.00027 (Reads [ACT R] in kΩ)

Setting the Limit Currents

For complete detail about setting the Limit Current, see Chapter 2.

*RS-232
Commands Discussed:*

[LIM I POSITIVE]
[LIM I NEGATIVE]

- Separate positive and negative current limits are available: [LIM I POSITIVE] and [LIM I NEGATIVE].
- For example, to configure the instrument with maximum currents of +1 Amp and -0.5 Amps, send the following two *Command Packets*.

Write

!101207+001.00020 (Sets [LIM I POSITIVE] in Amps)

!101208-000.5002D (Sets [LIM I NEGATIVE] in Amps)

- To read the instrument's limit current settings, the Command Type changes from a WRITE (2) to a READ (1):

Read

!101107+000.00022 (Reads [LIM I POSITIVE] in Amps)

!101108+000.0002D (Reads [LIM I NEGATIVE] in Amps)

- [LIM I POSITIVE] ranges from +000.000 to +005.000 Amps.
- [LIM I NEGATIVE] ranges from -005.000 to +000.000 Amps.

To Configure for a Resistive Heater

- Set [LIM I POSITIVE] to +000.000 Amps to operate a resistive heater.



Setting Temperature Limits

*RS-232
Commands Discussed:*

[T LIM HIGH]
[T LIM LOW]

For complete detail about setting the Temperature Limits, see Chapter 2, page 59.

- Separate high and low temperature limits are available to protect your load: [T LIM HIGH] and [T LIM LOW].
- For example, to configure the instrument with temperature limits of 50°C and 0°C, send the following two *Command Packets*.

Write

!101231+050.00021 (Sets [T LIM HIGH] in °C)

!101232+000.00027 (Sets [T LIM LOW] in °C)

- To read the current temperature limits, the Command Type changes from a WRITE (2) to a READ (1):

Read

!101131+000.00027 (Reads [T LIM HIGH] in °C)

!101132+000.00024 (Reads [T LIM LOW] in °C)

- Temperature Limits range from -199.900 to +199.900°C
- The temperature limits are disabled when thermistors or RTDs are configured to display resistance rather than temperature.

Autotune PID & Setting the P, I, and D Constants

RS-232
Commands Discussed:

[P]
[I]
[D]

For complete details about Autotune PID operation, see Chapter 2.

For complete detail about setting the P, I, and D constants, see Chapter 2.

The LFI-3751 with Autotune PID can optimize the PID control parameters to minimize temperature overshoot and reduce settling times with Setpoint Response Autotuning or to reject thermal transient effects on temperature stability by using Disturbance Rejection Autotuning.

The LFI-3751 can be configured to operate as a **P**, **PI**, **PD**, or **PID** temperature controller.

- To configure the instrument to begin an Autotune Optimization, send one of the following *Command Packets*.

Write

!101210-002.00023 (Sets **[P]** to AutS)

!101211-001.00021 (Sets **[P]** to Autd)

- To configure the instrument as a Proportional (**P**) controller with P = 30, send the following *Command Packets*.

Write

!101210+030.00024 (Sets **[P]** to 30)

!101211+000.00026 (Sets **[I]** to OFF)

!101212+000.00025 (Sets **[D]** to OFF)

- To configure the instrument as a **PI** controller with P = 30 and I = 1 second, send the following *Command Packets*.

Write

!101210+030.00024 (Sets **[P]** to 30)

!101211+001.00027 (Sets **[I]** to 1 second)

!101212+000.00025 (Sets **[D]** to OFF)



Chapter 4 - Remote Interface Reference
Setting the P, I, and D Constants

- To configure the instrument as a **PD** controller with P = 30 and D = 1 second, send the following *Command Packets*.

Write

!101210+030.00024 (Sets **[P]** to 30)
!101211+000.00026 (Sets **[I]** to OFF)
!101212+001.00024 (Sets **[D]** to 1 second)

- To configure the instrument as a **PID** controller with P = 30, I = 1 second, and D = 1 second, send the following *Command Packets*.

Write

!101210+030.00024 (Sets **[P]** to 30)
!101211+001.00027 (Sets **[I]** to 1 second)
!101212+001.00024 (Sets **[D]** to 1 second)

- To read the P, I, and D constants, the Command Type changes from a WRITE (2) to a READ (1):

Read

!101110+000.00024 (Reads **[P]**)
!101111+000.00025 (Reads **[I]**)
!101112+000.00026 (Reads **[D]**)

- **[P]** ranges from +001.000 to +100.000.
- **[I]** ranges from OFF (+000.000) or +000.400 to +010.000 seconds.
- **[D]** ranges from OFF (+000.000) or +001.000 to +010.000 seconds.

Setting Temperature Setpoint

*RS-232
Commands Discussed:*

[SET T]

For complete detail about setting the Operating Temperature, see Chapter 2.

- To configure the instrument with a temperature setpoint of 35°C, send the following *Command Packet*.

Write

!101203+035.00023

(Sets [SET T])

- To read the instrument's setpoint temperature, the Command Type changes from a WRITE (2) to a READ (1):

Read

!101103+000.00026

(Reads [SET T] in °C)

- Temperature Setpoint ranges from -199.900 to +199.900°C



RS-232
Commands Discussed:

[A1]
[A2]
[B1]
[B2]
[SET R]

Setting Resistance Setpoint

- To use resistance as the setpoint, you must be using a resistive sensor: thermistor or RTD. The following table shows the configuration settings and *Command Packets* to set the configuration for a thermistor or RTD in resistance mode.

How to Configure Thermistor and RTD for Resistance Setpoint

Sensor Type	Configuration / Setting	Command Packet: Write
Thermistor	[A1] = 0	!101221+000.00025
	[A2] = 0	!101222+000.00026
RTD	[A1] = 1	!101221+001.00024
	[A2] = 1	!101222+001.00027
	[B1] = 0	!101223+000.00027
	[B2] = 0	!101224+000.00020

- For example, after the sensor is properly configured, send the following *Command Packet* to configure the instrument with a resistance setpoint of 10 k Ω .

Write

!101204+010.00023 (Sets [SET R] in k Ω)

- To read the instrument's setpoint resistance, the Command Type changes from a WRITE (2) to a READ (1):

Read

!101104+000.00021 (Reads [SET R] in k Ω)

- Resistance Setpoint ranges from +000.000 to +499.900 k Ω

*RS-232
Commands Discussed:*

[RUN / STOP]

Enabling and Disabling the Output Current

For complete detail about Enabling the Output Current, see Chapter 2.

1. Enable Current

- To enable the instrument's output current send the following *Command Packet*.

Write

!101251+000.00123 *(Enable Output Current)*

2. Disable Current

- To disable the instrument's output current send the following *Command Packet*.

Write

!101251+000.00022 *(Disable Output Current)*

3. Monitor Output Status

- To read the output status, the Command Type changes from a WRITE (2) to a READ (1):

Read

!101151+000.00021

- The following table details the structure of the characters returned in the data field.

Char 7 = Sign Char [always +]
Char 6 = Not Used
Char 5 = Autotune Error Code
1 = Zero Value Current Limit Error
2 = Current Limit Cannot reach SET T
3 = Non-uniform TE I step measured
4 = Rate Sign Change
Char 4 = Autotune Status [0 = Normal Operation, 1 = Autotune Operation]
Char 3 = Decimal Point
Char 2 = Temp Limit or Sensor Error Status [1 = requires clearing]
Char 1 = Integrator Status [0 = OFF, 1 = ON]
Char 0 = Output Status [0 = OFF, 1 = ON]

If Character 2 is '1', a Temp Limit or Sensor Error has occurred. The next command to enable current will clear the error without enabling current.



Measuring Thermoelectric Current and Voltage

RS-232
Commands Discussed:

[TE I]
[TE V]

For complete detail about measuring thermoelectric current and voltage, see Chapter 2.

- To measure the thermoelectric current out of the instrument, send the following *Command Packet*.

Read

!101105+000.00020 (Reads [TE I] in Amps)

- To measure the thermoelectric voltage out of the instrument, send the following *Command Packet*.

Read

!101106+000.00023 (Reads [TE V] in Volts)

Measuring Auxiliary Sensor Temperature

*RS-232
Commands Discussed:*

[AUX T]

For complete detail about measuring temperature with the auxiliary sensor, see Chapter 2.

- To measure temperature of the auxiliary 10 k Ω thermistor wired to the instrument, send the following *Command Packet*.

Read
!101109+000.0002C (*Reads [AUX T] in °C*)



RS-232
Commands Discussed:
[MOD Gain Configuration]

Setting Gain for Analog Input Signal (Rear Panel BNC Connector)

- The instrument automatically sets the gain of the **Analog Input Connector** to match your sensor and bias current configuration. You can manually control the gain through the **[MOD Gain Configuration]** command. For Analog Input Gain 3, if you put in 1 Volt at the BNC, the setpoint changes 0.01 Volts.

Write

!101242+000.10021

(Sets Analog Input Gain to manual, 100 : 1)

- The following table details the structure of the characters in the data field.

Char 7 = Sign Char [+ = manual, - = automatic]
Char 6 = Not Used
Char 5 = Not Used
Char 4 = Not Used
Char 3 = Decimal Point
Char 2 = Analog Input Gain 3 (100 : 1) [0 = OFF, 1 = ON]
Char 1 = Analog Input Gain 2 (10 : 1) [0 = OFF, 1 = ON]
Char 0 = Analog Input Gain 1 (1 : 1) [0 = OFF, 1 = ON]

- When writing the **[MOD Gain Configuration]** command, Character 7 (+ or -) configures the instrument to manual or automatic mode. A '+' puts the Analog Input Gain under manual control. A '-' lets the instrument automatically change the gains. When Character 7 is '-', Characters 6 through 0 are ignored when writing. When the gain is controlled automatically, the transfer function changes with sensor and bias.

Analog Input Transfer Functions

Thermistors & RTDs (10 μ A or 100 μ A)	10 k Ω / V
Thermistors & RTDs (1 mA or 10 mA)	100 Ω / V
LM335/35, AD590	10 $^{\circ}$ C / V

- To read the MOD Gain Configuration, the Command Type changes from a WRITE (2) to a READ (1):

Read

!101142+000.00023

(Reads [MOD Gain Configuration])

Checking the Alarm Status

RS-232
Commands Discussed:

[Alarm Status]

- To monitor the status of the Sensor Error, Temperature Limits, Current Limits, and Output Current, use the **[Alarm Status]** command. To read the Alarm Status of the instrument, send the following *Command Packet*.

Read

!101135+000.00023 (*Reads [Alarm Status]*)

- The following table details the structure of the characters in the data field.

Char 7 = Sign Char [always +]
Char 6 = Sensor Open Error [0 = OK, 1 = Error]
Char 5 = Sensor Short Error [0 = OK, 1 = Error]
Char 4 = Low Temperature Limit [0 = OK, 1 = Error]
Char 3 = Decimal Point
Char 2 = High Temperature Limit [0 = OK, 1 = Error]
Char 1 = Current Limit [0 = OK, 1 = Error]
Char 0 = Output Current ON/OFF status [0 = OFF, 1 = ON]

4



RS-232
Commands Discussed:

[HALT PROCESSOR]

Halting the Processor

- The [HALT PROCESSOR] command turns all front panel lamps off, disables interrupts, shuts off all timers, clocks, and the watchdog then freezes the CPU. To stop the processor on the instrument, send the following *Command Packet*.

Write
!101252+000.00021 (*Halts Processor*)

- You have to power off the instrument for 30 seconds before resuming operation.
- No *Response Packet* is returned when this command is executed.

Reverting to LOCAL Mode

*RS-232
Commands Discussed:*

[LOCAL]

- To switch from computer to front panel control of the instrument, use the [LOCAL] command. To revert to LOCAL mode, send the following *Command Packet*.

Write

!101253+000.00020 ([LOCAL])

- Before reverting to LOCAL mode, the instrument will return a *Response Packet*.



Entering the PASSWORD

*RS-232
Commands Discussed:*

[PASSWORD]

- Prior to writing a Calibration or Diagnostic *Command Packet*, the instrument must be given the proper password. To confirm the PASSWORD, send the following *Command Packet*. Note that the '???????' represents the eight ASCII characters in the actual password.

Write

!101254???????(FCS) ([PASSWORD])

- This data field does not follow the standard format. These eight characters are only restricted to ASCII characters.
- The PASSWORD can be obtained by calling Wavelength Electronics Technical Support or your local distributor.
- To read the status of PASSWORD access, send the following *Command Packet*. A '0' returned in Character 0 indicates the PASSWORD has not been issued. A '1' returned in Character 0 indicates the PASSWORD has been issued properly.

Read

!101154+000.00024 (Reads Status of password flag)

Reading Serial & Model Numbers, Firmware Version

RS-232
Commands Discussed:

[SERIAL NUMBER]
[FIRMWARE VERSION]
[MODEL NUMBER]

- These data fields do not follow the standard format. These eight data field characters are only restricted to ASCII characters.

- To read the instrument's Serial Number, send the following *Command Packet*.

Read

!101155+000.00025 (*Reads Serial Number 'XXXXXXXX'*)

- To read the instrument's Firmware Version, send the following *Command Packet*.

Read

!101156+000.00026 (*Reads Firmware Version 'XXXXXXXX'*)

- To read the instrument's Model Number, send the following *Command Packet*.

Read

!101157+000.00027 (*Reads Model Number 'XXXXXXXX'; should return "LFI-3751"*)



RS-232
Commands Discussed:

[PASSWORD]
[10 μ A BIAS CAL]
[100 μ A BIAS CAL]
[1 mA BIAS CAL]

Calibration - Sensor Bias Current and AD590 Sense Resistance

- All sensor bias currents and the AD590 sense resistance are calibrated at the factory. To change these calibrated values, you must first send the [PASSWORD] command. You should not use these commands without direct supervision from Wavelength Electronics Technical Support Group.

Write

!101254??????? (FCS) ([PASSWORD])

Calibrating the 10 μ A Reference Current

- If the instrument's 10 μ A reference current is actually 9.89 μ A, send the following *Command Packet* to properly calibrate the unit.

Write

!101261+009.89029 ([10 μ A BIAS CAL] in μ A)

Calibrating the 100 μ A Reference Current

- If the instrument's 100 μ A reference current is actually 99.5 μ A, send the following *Command Packet* to properly calibrate the unit.

Write

!101262+099.50027 ([100 μ A BIAS CAL] in μ A)

Calibrating the 1 mA Reference Current

- If the instrument's 1 mA reference current is actually 1.005 mA, send the following *Command Packet* to properly calibrate the unit.

Write

!101263+001.00527 ([1 mA BIAS CAL] in mA)

RS-232
Commands Discussed:

[10 mA BIAS CAL]
[AD590 10 kΩ CAL]

Calibrating the 10 mA Reference Current

- If the instrument's 10 mA reference current is actually 10.262 mA, send the following *Command Packet* to properly calibrate the unit.

Write

!101264+010.26223 (*[10 mA BIAS CAL] in mA*)

Calibrating the 10 kΩ Resistance (for AD590)

- If the instrument's 10 kΩ resistance is actually 10.003 kΩ, send the following *Command Packet* to properly calibrate the unit.

Write

!101265+010.00327 (*[AD590 10 kΩ CAL] in kΩ*)

Reading the Sensor Bias Current and AD590 Sense Resistance Settings

- To read the sensor bias and AD590 sense resistance settings, the Command Type changes from a WRITE (2) to a READ (1) and no [PASSWORD] is required:

Read

!101161+000.00022 (*Reads [10 μA BIAS CAL] in μA*)

!101162+000.00021 (*Reads [100 μA BIAS CAL] in μA*)

!101163+000.00020 (*Reads [1 mA BIAS CAL] in mA*)

!101164+000.00027 (*Reads [10 mA BIAS CAL] in mA*)

!101165+000.00026 (*Reads [AD590 10kΩ CAL] in kΩ*)



RS-232
Commands Discussed:

[RAW ACT T VOLT]
[RAW TE I VOLT]
[RAW TE V VOLT]

Calibration- ACT T, TE I, TE V uncalibrated voltages

Reading the uncalibrated ACT T voltage

- This command reads the uncalibrated ACT T voltage from the instrument's A/D. This command is useful for calculating the instrument's ACT T Slope and Offset. To read the uncalibrated ACT T voltage, send the following *Command Packet*.

Read

!101171+000.00023 ([RAW ACT T VOLT] in Volts)

Reading the uncalibrated TE I voltage

- This command reads the uncalibrated TE I voltage from the instrument's A/D. This command is useful for calculating the instrument's TE I Slope and Offset. To read the uncalibrated TE I voltage, send the following *Command Packet*.

Read

!101172+000.00020 ([RAW TE I VOLT] in Volts)

Reading the uncalibrated TE V voltage

- This command reads the uncalibrated TE V voltage from the instrument's A/D. This command is useful for calculating the instrument's TE V Slope and Offset. To read the uncalibrated TE V voltage, send the following *Command Packet*.

Read

!101173+000.00021 ([RAW TE V VOLT] in Volts)

RS-232
Commands Discussed:

[PASSWORD]
[ACT T SLOPE CAL]
[ACT T OFFSET CAL]
[TE I SLOPE CAL]
[TE I OFFSET CAL]
[TE V SLOPE CAL]
[TE V OFFSET CAL]

Calibration - Measurement Slopes & Offsets

- All measurements are calibrated at the factory. To change these calibrated values, you must first send the **[PASSWORD]** command. You should not use these commands without direct supervision from Wavelength Electronics Technical Support Group.

Write

!101254????????(FCS) ([PASSWORD])

Calibrating ACT T Slope & Offset

- These commands are used to calculate the instrument's ACT T measurement.

Write

!101274+001.00024 ([ACT T SLOPE CAL])

!101275+000.00024 ([ACT T OFFSET CAL] in Volts)

Calibrating TE I Slope & Offset

- These commands are used to calculate the instrument's TE I measurement.

Write

!101276+001.00026 ([TE I SLOPE CAL])

!101277+000.00026 ([TE I OFFSET CAL] in Amps)

Calibrating TE V Slope & Offset

- These commands are used to calculate the instrument's TE V measurement.

Write

!101278+001.00028 ([TE V SLOPE CAL])

!101279+000.00028 ([TE V OFFSET CAL] in Volts)



Reading the ACT T, TE I, TE V Slopes and Offsets

- To read the measurement calibration settings, the Command Type changes from a WRITE (2) to a READ (1) and no **[PASSWORD]** is required:

Read

!101174+000.00026	<i>(Reads [ACT T SLOPE CAL])</i>
!101175+000.00027	<i>(Reads [ACT T OFFSET CAL] in Volts)</i>
!101176+000.00024	<i>(Reads [TE I SLOPE CAL])</i>
!101177+000.00025	<i>(Reads [TE I OFFSET CAL] in Amps)</i>
!101178+000.0002A	<i>(Reads [TE V SLOPE CAL])</i>
!101179+000.0002B	<i>(Reads [TE V OFFSET CAL] in Volts)</i>

*RS-232
Commands Discussed:*

[PASSWORD]
[POS SET T SLOPE CAL]
[POS SET T OFFSET CAL]
[NEG SET T SLOPE CAL]
[NEG SET T OFFSET CAL]

Calibration - SET T Slopes & Offsets

- The setpoint temperature values are calibrated at the factory. To change these calibrated values, you must first send the [PASSWORD] command. You should not use these commands without direct supervision from Wavelength Electronics Technical Support Group.

Write

!101254??????? (FCS) ([PASSWORD])

Calibrating Positive SET T Slope & Offset

- These commands calibrate the positive voltage SET T setpoints.

Write

!101280+001.0002F ([POS SET T SLOPE CAL])

!101281+000.0002F ([POS SET T OFFSET CAL] in Volts)

Calibrating Negative SET T Slope & Offset

- These commands calibrate the negative voltage SET T setpoints.

Write

!101282+001.0002D ([NEG SET T SLOPE CAL])

!101283+000.0002D ([NEG SET T OFFSET CAL] in Volts)

Reading the Current Calibration Settings

- To read the current calibration settings, the Command Type changes from a WRITE (2) to a READ (1) and no [PASSWORD] is required.

Read

!101180+000.0002D (Reads [POS SET T SLOPE CAL])

!101181+000.0002C (Reads [POS SET T OFFSET CAL] in Volts)

!101182+000.0002F (Reads [NEG SET T SLOPE CAL])

!101183+000.0002E (Reads [NEG SET T OFFSET CAL] in Volts)



RS-232
Commands Discussed:

[PASSWORD]
[T POS LIM I SLOPE CAL]
[T POS LIM I OFFSET CAL]
[T NEG LIM I SLOPE CAL]
[T NEG LIM I OFFSET CAL]

Calibration - TE Limit Current Slopes & Offsets

- The TE Limit Current values are calibrated at the factory. To change these calibrated values, you must first send the [PASSWORD] command. You should not use these commands without direct supervision from Wavelength Electronics Technical Support Group.

Write
!101254???????(FCS) ([PASSWORD])

Calibrating LIM I POSITIVE Slope & Offset

- These commands calibrate the positive limit current settings.

Write
!101284+001.0002B ([TE POS LIM I SLOPE CAL])
!101285+000.0002B ([TE POS LIM I OFFSET CAL] in Amps)

Calibrating LIM I NEGATIVE Slope & Offset

- These commands calibrate the negative limit current settings.

Write
!101286+001.00029 ([TE NEG LIM I SLOPE CAL])
!101287+000.00029 ([TE NEG LIM I OFFSET CAL] in Amps)

Reading the Current Calibration Settings

- To read the current calibration settings, the Command Type changes from a WRITE (2) to a READ (1) and no [PASSWORD] is required.

Read
!101184+000.00029 (Reads [TE POS LIM I SLOPE CAL])
!101185+000.00028 (Reads [TE POS LIM I OFFSET CAL] in Amps)
!101186+000.0002B (Reads [TE NEG LIM I SLOPE CAL])
!101187+000.0002A (Reads [TE NEG LIM I OFFSET CAL] in Amps)

RS-232
Commands Discussed:

[PASSWORD]
[RESTORE FACTORY
CALIBRATION DEFAULTS]

RESTORE Calibration Defaults

- To issue this command you must first send the [PASSWORD] command. You should not use this command without direct supervision from Wavelength Electronics Technical Support Group. To revert this instrument back to the default settings, send the following *Command Packets*.

Write

!101254????????(FCS)

([PASSWORD])

!101288+000.00026

**([RESTORE FACTORY
CALIBRATION DEFAULTS])**

- NOTICE!** This command will clear the calibration E²PROM and clear any previous calibration values. All slopes will reset to '1' and offsets to '0'. The sensor bias currents will become 10 μ A, 100 μ A, 1 mA, and 10 mA. The AD590 sense resistance returns to 10 k Ω . The serial number will revert to CALLWE.



Diagnostic - Lamp Control

RS-232
Commands Discussed:

[LAMP CONTROL]

- The [LAMP CONTROL] command tests whether the LEDs or 7 segment displays are properly operating.
- Six test states are provided. The following table details the structure of the characters in the data field. Only one test state is allowed per *Command Packet*. For example, you can turn on the 7 Segment Display with one *Command Packet* and the Status LEDs with a second *Command Packet*.

Char 7 = Sign Char ['+' = manual, '-' = automatic]
Char 6 = Sequence Lamps, Sound Beeper [0 = OFF, 1 = Lamp ON]
Char 5 = All Lamps On [0 = OFF, 1 = Lamp ON]
Char 4 = 7 Segment Displays [0 = OFF, 1 = Lamp ON]
Char 3 = Decimal Point
Char 2 = Unit of Measure & Shift LEDs [0 = OFF, 1 = Lamp ON]
Char 1 = Status LEDs [0 = OFF, 1 = Lamp ON]
Char 0 = Output ON LED [0 = OFF, 1 = Lamp ON]

- For example, to turn on an instrument's Unit of Measure & Shift LEDs, send the following *Command Packet*.

Write

!101291+000.1002F (*Turns on Unit of Measure & Shift LEDs*)

- Once the *Command Packet* is executed, the test state will be repeated until the instrument is returned to normal operation.
- To return the instrument to normal operation, either turn off the power or send a *Command Packet* with a '-' in Character 7.

RS-232
Commands Discussed:
[PUSHBUTTON SWITCH
STATUS]
[ROTARY SWITCH STATUS]

Diagnostic - Switch Status

Output, Shift, and Temp Limit Pushbutton Status

- The following table details the structure of the characters in the data field for the [PUSHBUTTON SWITCH STATUS] command.

Char 7 = Sign Char (Not Used)
Char 6 = Not Used
Char 5 = Not Used
Char 4 = Not Used
Char 3 = Decimal Point
Char 2 = Temp Limit Pushbutton [0 = OFF, 1 = ON]
Char 1 = Shift Pushbutton [0 = OFF, 1 = Lamp ON]
Char 0 = Output Pushbutton [0 = OFF, 1 = Lamp ON]

- To read the current status of the pushbutton switches, send the following *Command Packet*.

Read

!101192+000.0002E (*Reads [Pushbutton Switch Status]*)

Rotary Switch Status

- The following table details the structure of the characters in the data field for the [ROTARY SWITCH STATUS] command. A '1' indicates the position of the rotary switch.

Char 7 = Sign Char (Not Used)
Char 6 = AUX T / C
Char 5 = LIM I / B
Char 4 = TE V / A
Char 3 = Decimal Point
Char 2 = TE I / D
Char 1 = SET T / I
Char 0 = ACT T / P

- To read the current status of the Rotary switch, send the following *Command Packet*.

Read

!101193+000.0002F (*Reads [Rotary Switch Status]*)



RS-232
Commands Discussed:

[DIGIPOT STATUS]

Diagnostic - Digi-Pot Status

- The [DIGIPOT STATUS] command reads whether the Digi-Pot is moving clockwise or counterclockwise and quantifies how far it has rotated since it was last cleared.
- The Digi-Pot Counter increases when the Digi-Pot is moving at 32 counts per rotation.
- When the Digi-Pot is not moving, sending this command will clear the Digi-Pot Counter.
- When the Digi-Pot is moving, this command reads the Digi-Pot Counter.
- When the Digi-Pot is moving clockwise, the counter increases. When the Digi-Pot is moving counter clockwise, the counter decreases.
- The following table details the structure of the characters in the data field for the [DIGIPOT STATUS] command.

Char 7 = Sign Char ['+' = clockwise, '-' = counterclockwise]
Char 6, 5, 4 = Integer number of counts since last cleared
Char 3 = Decimal Point
Char 2 = 0
Char 1 = 0
Char 0 = 0

- To read the current status of the Digi-Pot, send the following *Command Packet*.

Read
!101194+000.00028 (*Reads [DIGIPOT STATUS]*)

End Code Reference

00 - Normal Ending

Command in the *Command Packet* has been processed correctly and *Response Packet* contains valid data. Data is not valid if any other End Code is returned.

01 - Command Type Not Supported

Fifth character of the *Command Packet* (Command Type) contains a character other than '1' or '2'. Only 1 = Read and 2 = Write are supported Command Types.

02 - Illegal ASCII Digit

The Command Code or FCS fields contain an illegal ASCII digit. The Command Code can accept '00' through '99'. FCS is a HEX number, so can accept '00' through 'FF'.

03 - Invalid Data Character 7

This character must contain either '+' or '-'.

04 - Invalid Data Character 3

This character must contain a decimal point '.'

05 - Invalid ASCII Data Character Digit

Characters 6, 5, 4, 2, 1, or 0 must contain a valid ASCII digit '0' through '9'.

20 - Command Code does not support CommandType

Certain Command Codes can only read data and other Command Codes can only write data. Some do both. For example, measurement codes are read only commands. If you send an [ACT T] code with a '2' in the fifth character (Command Type = WRITE), the *Response Packet* will return with this End Code.



21 - PASSWORD Required

The *Command Packet* attempts to write password protected data. The [PASSWORD] command must be issued first.

22 - Command Number Not Implemented

The *Command Packet* uses a Command Code that is not recognized.

23 - Calculated FCS does not Match Transmitted FCS

The Frame Check Sum is used to verify proper transmission of data. If the calculated FCS does not match the transmitted FCS, either the data was corrupted in transmission or the FCS in the *Command Packet* was incorrectly calculated.

24 - Parser Programming Error

Please contact the factory if a *Response Packet* returns this End Code.

25 - Invalid Data Character

The parser expects only a '0' or '1' in one of the data characters. Some other ASCII value was transmitted.

26 - Query Calculation Error

The LFI-3751 was unable to calculate the requested measurement. Data in the *Response Packet* is '+999.999'. This occurs when the sensor is open or shorted. This also occurs when the sensor is improperly configured or out of the temperature range.

27 - Sensor Data not Updated

Sensor configuration data cannot be changed while the Output is ON.

81 - RS-232 Lamp Control Write Error

The [LAMP CONTROL] command allows only one test condition at a time. Only one of the data characters can be a '1'.

Calculating FCS

- FCS (Frame Check Sum) is used to assure that the RS-232 transmission was not corrupted.
- The following BASIC routine calculates the FCS for a *Command* or *Response Packet*.

```
BASIC Routine for calculating FCS 1110 'Copy either Command$ or Response$ into Packet$
1120 'Run FCS Generator routine: FCSGEN
1130 'For Command Packets, the routine generates the proper FCS
1140 'For Response Packets, the routine compares the FCS received to
1150 'a calculated FCS and returns the FCSVALID flag
1160 FCSGEN:
1170 FCS = 0
1180 FCSVALID = "TRUE"
1190 Input Packet$
1200 STARTCHAR$=MID$(Packet$,1,1)
1210 IF STARTCHAR$ = "!" THEN FCSLEN = LEN(Packet$)
1220 IF STARTCHAR$ = "@" THEN FCSLEN = LEN(Packet$) - 4
1230 IF STARTCHAR$ <> "!" OR STARTCHAR$ <> "@" THEN FCSVALID = "FALSE"
1240 For IFCS=1 to FCSLEN
1250     FCS=FCS XOR ASC(MID$(Packet$, IFCS, 1))
1260 Next
1270 FCS$=RIGHT$("0",HEX$(FCS),2)
1280 IF STARTCHAR$ = "@" and FCS$ <> MID$(Packet$,18,2) THEN FCSVALID = "FALSE"
```

- The following Visual C++ routine calculates the FCS for a *Command* or *Response Packet*.

Visual C++ Routine for calculating FCS

```
static BYTE ComputeFCS ( const CString& srPreFcsCmd )
{
    BYTE ucFCS = 0;    // zero FCS byte
    // For debugging: Validate CString object reference is to the first part of a Command or
    //Response Packet
    ASSERT( srPreFcsCmd.GetAt(0) == '!' || srPreFcsCmd.GetAt(0) == '@' );
    ASSERT( srPreFcsCmd.GetLength() == 15 || srPreFcsCmd.GetLength() == 17 );
    // Loop through each character of the string and 'Exclusive OR' result
    // with next character. Byte returned should match transmitted FCS.
    for( BYTE ucCharIdx = 0; ucCharIdx < srPreFcsCmd.GetLength(); ucCharIdx++ )
        ucFCS ^= (BYTE) srPreFcsCmd.GetAt( ucCharIdx );
    return ucFCS;
}
```

srPreFcsCmd contains the *Command Packet* up to the FCS characters.

- The instrument always checks the *Command Packet's* FCS against the calculated FCS. The host computer program can use the *Response Packet's* FCS to verify proper communication from the instrument but it is not necessary.



Example BASIC Control Program for IBM PC Compatible Machines

```
1000 ' LFI-3751 RS-232 Control Program for IBM PC Compatible Machines
1001 '
1002 ' Configure the COM Port #1 for RS-232 communications with the following settings
1003 '
1004 '   Baud: 19200
1005 '   Parity: None
1006 '   Data: 8
1007 '   Stop: 1
1008 '
1009 OPEN "COM:19200,N,8,1,CD0,CS0,DS0,RB256,RS" FOR RANDOM AS #1 LEN=256
1010 '
1011 ' Get the instruments RS-232 address
1012 '
1013 PRINT "Enter instrument's RS-232 address [i.e. 01]";
1014 INPUT ADDRESS$
1015 '
1016 ' The following loop issues command packets to the instrument and prints out the
1017 ' instrument's response packets
1018 '
1019 RS232LOOP:
1020 '
1021 ' Determine if the command is a read or write command and enter a valid command
1022 ' code. Enter a valid data field.
1023 '
1024 PRINT "Enter command type [ 1 - Read , 2 - Write]:";
1025 INPUT TYPE$
1026 PRINT "Enter command code:";
1027 INPUT CODE$
1028 IF TYPE$="1" THEN DATA$="+000.000"
1029 ELSE PRINT$ "Enter data [i.e. "xxx.xxx"];:INPUT DATA$
1030 COMMAND$="!1"+ADDRESS$+TYPE$+CODE$+DATA$
1031 '
```

Chapter 4 - Remote Interface Reference
Example BASIC Control Program for IBM PC Compatible Machines

```
1032 ' Calculate the Frame Check Sum (FCS) for the entered command
1033 '
1034 FCS=0
1035 FOR IFCS=1 TO LEN(COMMAND$)
1036   FCS=FCS XOR ASC(MID$(COMMAND$,IFCS,1))
1037 NEXT
1038 FCS$=RIGHT$("0"+HEX$(FCS),2)
1039 '
1040 ' Issue command packet to the instrument
1041 '
1042 PRINT #1, COMMAND$+FCS$
1043 '
1044 ' Receive the response packet back from the instrument
1045 '
1046 RCNT=0
1047 RECV$=""
1048 RLOOP:
1049 '
1050 ' If the COM port buffer contains data then process data in RDATA loop otherwise
1051 ' keep track of time gone by since data has been entered into COM port buffer.
1052 '
1053 IF LOC(1) <> 0 THEN RDATA
1054 RCNT=RCNT+1
1055 '
1056 ' If no data has been entered into the COM port buffer by the time the counter RCNT
1057 ' reaches 100000 then indicate the instrument is not responding. If you receive the
1058 ' "No Response!" error too frequently then increase the error count value.
1059 '
1060 IF RCNT=100000 THEN RERROR
1061   ELSE RLOOP
1062 '
```



Chapter 4 - Remote Interface Reference
Example BASIC Control Program for IBM PC Compatible Machines

```
1063 ' The following loop sums the COM port buffer to create a response packet.
1064 ' If 21 characters are detected in the COM port buffer, then the response packet is
1065 ' printed to the screen.
1066 '
1067 RDATA:
1068 RECV$ = RECV$ + INPUT$(LOC(1),#1)
1069 IF LEN(RECV$) = 21 THEN REND
1070   ELSE RCNT=0: GOTO RLOOP
1071 '
1072 ' No response packet received.
1073 '
1074 RERROR:
1075 RECV$ = "No Response!"
1076 '
1077 ' Print the response packet.
1078 '
1079 PRINT "Instrument's response packet is: "; RECV$
1080 '
1081 ' Send another packet or end program
1082 '
1083 PRINT "Continue [ Y or N]?";
1084 INPUT C$
1085 IF C$ = "Y" THEN RS232LOOP
1086 CLOSE #1
1087 END
```

Chapter 5: Specifications



Specifications

This chapter details the General, Electrical, and Mechanical Specifications of the LFI-3751 Temperature Controller.



General Specifications

Power Supply:	115 / 230 \pm 15% VAC (Switch Selectable)	Acoustic Noise:	26 dBa
Power-Line Frequency:	60/50 Hz	Warm-Up Time:	1 hour
Power Consumption:	160 VA peak 25 Watt average (Output Off) 55 Watt average (Output On)	Warranty:	1 year standard
Operating Environment:	0 to 55°C 80% Relative Humidity to 30°C	Remote Interface:	RS-232 standard
Storage Environment:	-40°C to 70°C	Accessories Included:	User's Guide, Test Report, connector kit, and power cord
State Storage:	Power OFF State Automatically Saved	Cleaning Instructions:	Clean with dry, lint free cloth
Dimensions:	(W x D x H)		
Bench Top:	4.25" x 12" x 6.5" (108 mm x 305 mm x 165 mm)		
Weight:	4.5 kg (10 lbs)		

Electrical Specifications

Temperature Control		Display (4 digit)	
Short Term Stability, 1 hr. ❶	< 0.002°C	Temperature	- 199.9 to +199.9°C
Long Term Stability, 24 hr. ❶	< 0.005°C	Resistance	0 to 499.9 k Ω
Setpoint Resolution	12 bit D to A	TE Current	- 5.00 to +5.00 A
TEC Output		TE Voltage	- 9.99 to +9.99 V
Bipolar Output Current	\pm 5.0 A	Measurement Resolution	15 bit A to D
Compliance Voltage	\pm 8 V	Sensors Supported	
Maximum Output Power	40 W	Thermistors	0 to 499.9 k Ω
Current Limit Range	0 to \pm 5.0 A	RTDs	0 to 499.9 k Ω
Control Loop	P, PI, PD, PID	AD590	
Proportional Gain, adjustable	AutS, Autd, 0 to 100 Amps / Volt	LM335	
Integrator Time Constant, adjustable	OFF or 0.4 to 10.0 seconds	LM35	
Differentiator, adjustable	OFF or 1 to 100 seconds	❶ Stability quoted for a typical 10 k Ω thermistor at 100 μ A bias current. One hour to rated stability.	

Mechanical Specifications

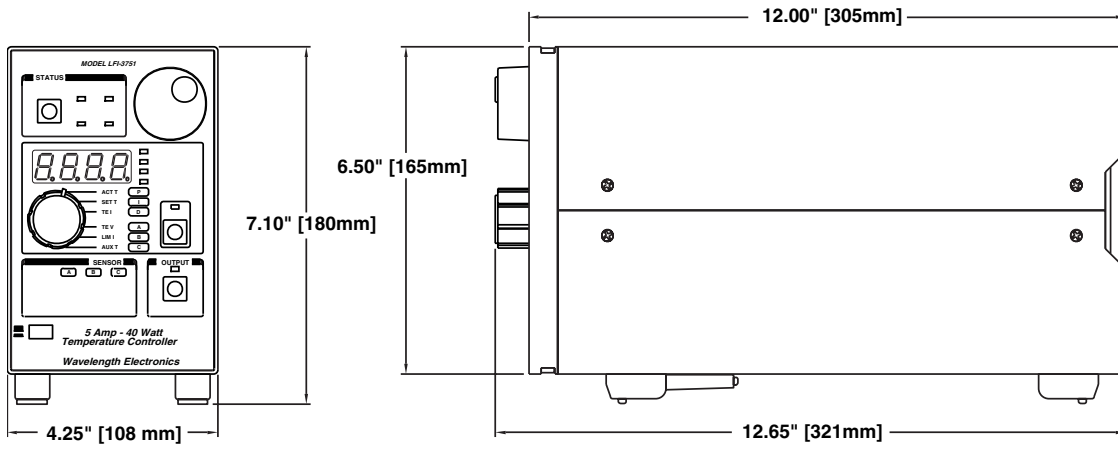



**Appendix:
CAT-220 Cable Accessory Diagram**



Appendix
CAT-220 Cable Accessory Diagram

CAT-220 Cable Accessory Diagram

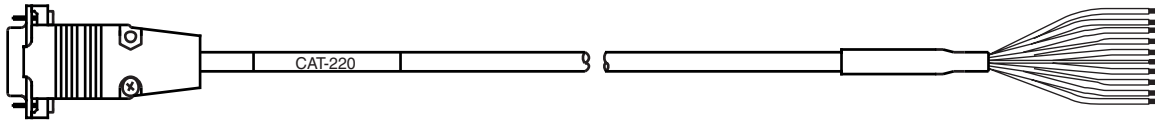

Pin	Description	Wire color
1	TEC +	RED
2	TEC -	BLACK
3	Aux Sensor +	BROWN
4	Sensor -	GREEN
5	Main Sensor +	WHITE
6	AD590 Voltage	ORANGE
7	Fan -	YELLOW
8	Fan+ (+12 V)	BLUE
9	-12 V	PURPLE
SHELL		SLATE